

# U2 PSA™ Knee

Revision Knee System



Surgical Technique Guide

# Table of Contents

---

<b>Device Description</b> .....	II
<b>Surgical Overview</b> .....	IV
<b>Revision Procedure</b>	
A. Component Removal.....	1
B. Tibial Canal Preparation .....	2
C. Proximal Tibial Preparation.....	3
D. Non Offset Tibial Preparation.....	5
E. Offset Tibial Preparation .....	8
F. Femoral Canal Preparation .....	12
G. Distal Femoral Preparation .....	14
H. Non Offset Femoral Preparation .....	16
I. Offset Femoral Preparation .....	21
J. Trial Reduction .....	25
K. Final Tibial Preparation .....	27
L. Final Trial Reduction .....	29
M. Implantation .....	30
<b>Order Information</b> .....	41

# Device Description

## **U2 PSA Knee –**

The U2 PSA (Posterior Stabilized Augmentable) Revision Knee System adopts basic design concepts of the Primary U2 Knee System and offers full size interchangeability across its component ranges. A full range of extension press-fit stem, femoral and tibial augments are available. For severe bone deficiencies and complex cases, U2 PSA knee offers options for increased constraint and a combination of various augment thickness and extension stem length options.

## **INDICATIONS**

This device is indicated in knee arthroplasty in skeletally mature patients with severe knee pain and disability due to rheumatoid arthritis, osteoarthritis, primary and secondary traumatic arthritis, polyarthritis, collagen disorders, avascular necrosis of the femoral condyle or pseudogout, posttraumatic loss of joint configuration, particularly when there is patellofemoral joint surface erosion, dysfunction or prior patellectomy, moderate valgus, varus, or flexion contraction. This device is intended for use in patients who require augmentation and/or stem extensions due to inadequate bone stock and/or require increased stabilization for tibiofemoral joint due to soft tissue imbalance. The femoral and tibial augments are to be attached to their respective components with a fixation screw or screws.

*Please refer to the package inserts for important product information, including, but not limited to contraindications, warnings, precautions, and adverse effects.*

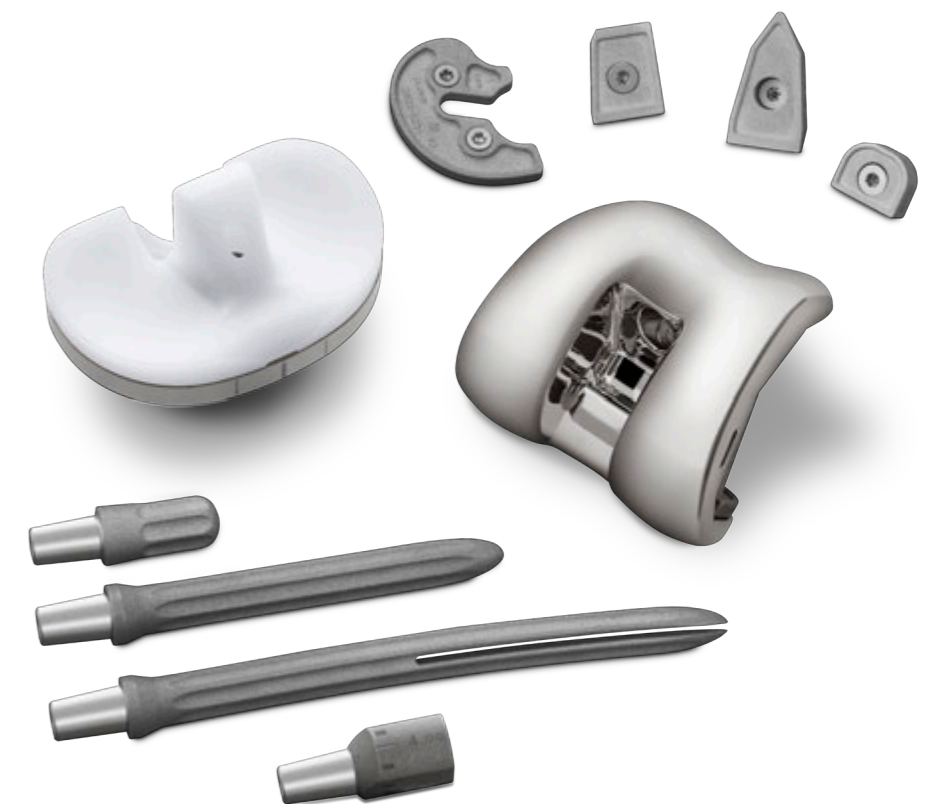

# Surgical Overview

## Femoral Preparation

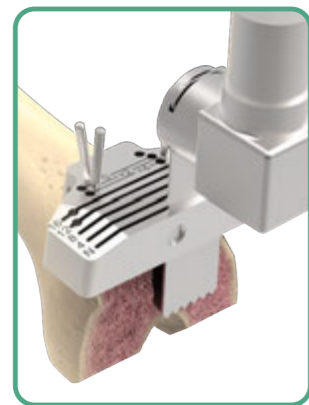

Distal Femoral Preparation

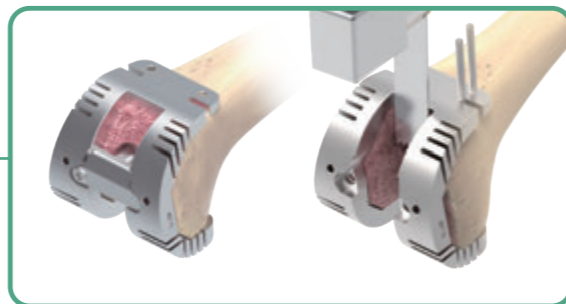

Non Offset Femoral Preparation

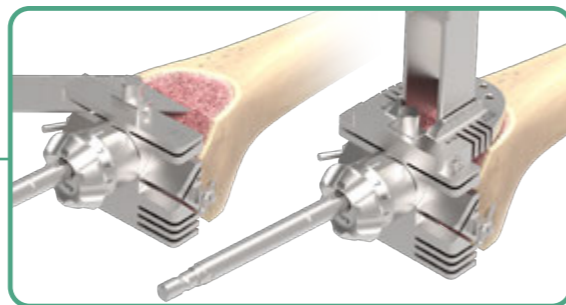

Offset Femoral Preparation

## Tibial Preparation

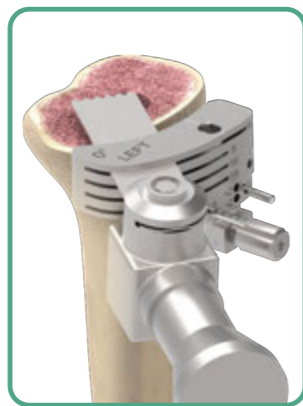

Proximal Tibial Preparation

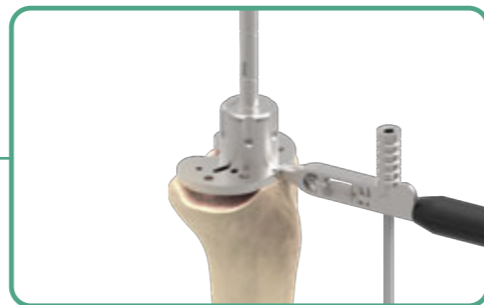

Non Offset Tibial Preparation

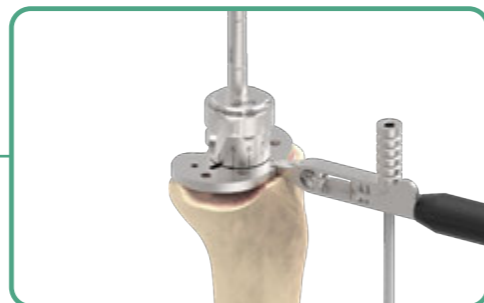

Offset Tibial Preparation



Trial Reduction

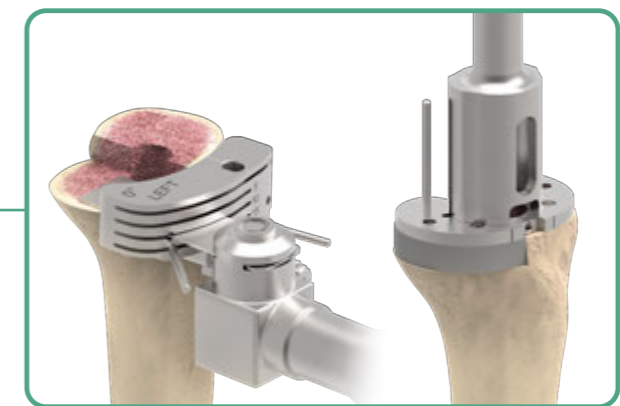

Final Tibial Preparation



Final Trial Reduction

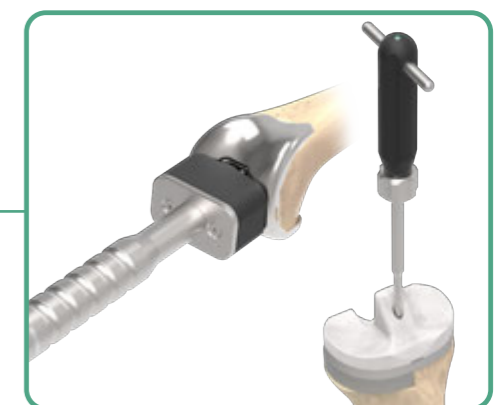

Implantation

# A. Component Removal

When removing the components, great care must be taken to preserve as much of the remaining bone stock as possible and to avoid the risk of fracture of the residual bone stock. Through the use of small flexible osteotomes, saws, and high-speed burring instruments, bone preservation can usually be achieved.

# B. Tibial Canal Preparation

After removing the tibial component, remove residual cement and other debris. If necessary, center the drill and create an entry hole with the 9 mm diameter **Straight Stem Reamer**.

Progressively ream the tibial Intramedullary (IM) canal starting with the smallest diameter **Straight Stem Reamer** and gradually increasing the reamer diameter (9 mm to 24 mm in 1 mm increments) until the appropriate diameter and depth is achieved as indicated on the etched markings on the reamers.

Note the diameter and length reamed of the final reamer used for reference in a future step.

**Note:**

T : Tibial Component with the Stem

TA : Tibial Component with Stem + Adapter

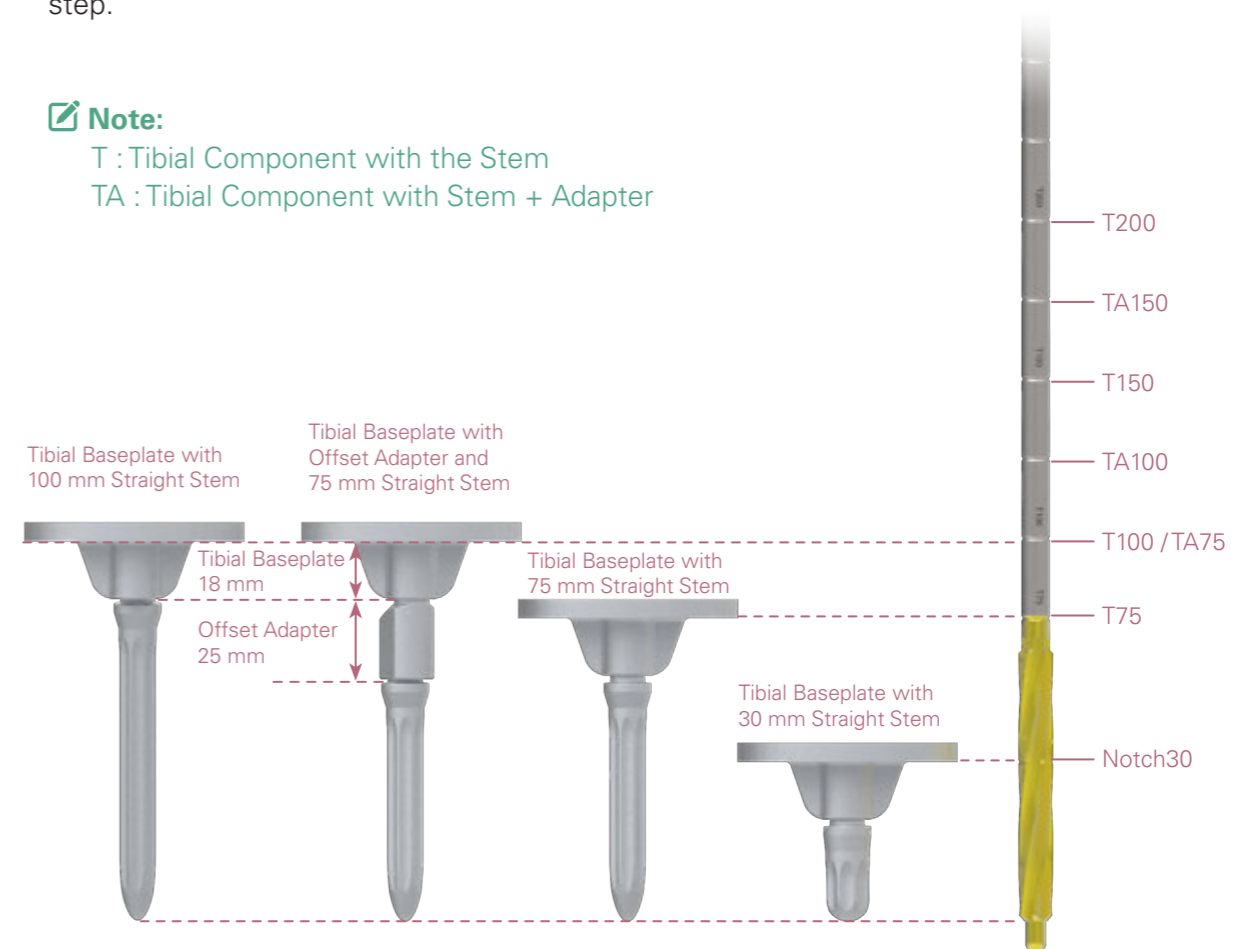

**Instruments**



Straight Stem Reamer

# C. Proximal Tibial Preparation

Attach the **IM Guide Collar** to the **Tibial IM Alignment Guide**. Then slide the **Tibial Resection Guide** onto the **Tibial IM Alignment Guide**.



Instruments



IM Guide Collar Tibial IM Alignment Guide Tibial Resection Guide

# C. Proximal Tibial Preparation

Place the appropriate **Straight Stem Reamer** (or the **Tibial IM Rod**) into the reamed tibial IM canal. Insert the tibial resection assembly onto the reamer until the **IM Guide Collar** is sitting flat against the proximal tibial surface. Tighten the **Tibial IM Alignment Guide** to the reamer.

Move the **Tibial Resection Guide** until it is positioned against the anterior portion of the proximal tibia. Secure the **Tibial Resection Guide** with 2 **Round Pins** secured in the parallel central zero pin holes marked '0'. Secure with additional **Round Pins** in the angled pin holes as needed for additional stability prior to resecting.

Perform a 2 mm resection through the 'N' slot. Note: If adjustment for the resection is needed, utilize the +2 mm or -2 mm holes to relocate the **Tibial Resection Guide** accordingly.

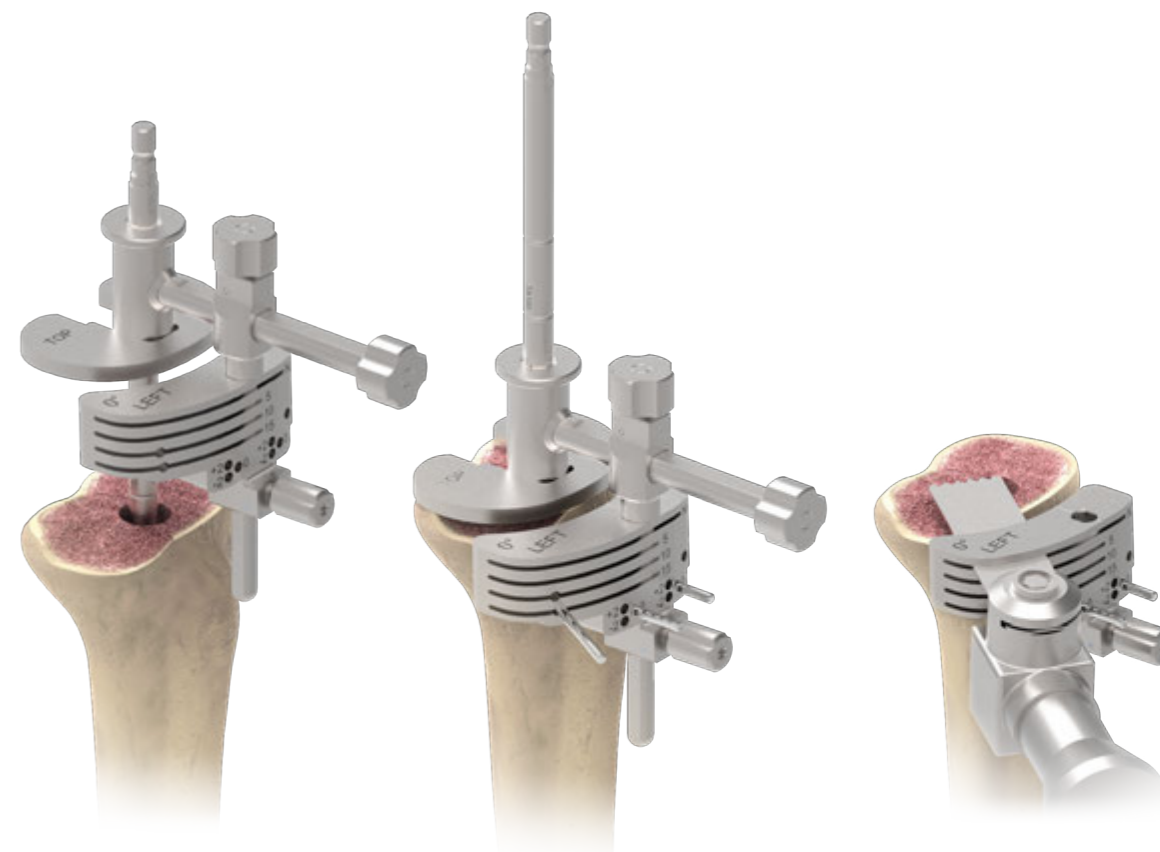

Instruments



Straight Stem Reamer IM Guide Collar Tibial IM Alignment Guide Tibial Resection Guide Tibial IM Rod Round Pin

# D. Non Offset Tibial Preparation

Select the proper size **Tibial Sizing Template** that provides desired tibial coverage and attach it to the **Tibial Sizing Template Handle**.

Place the assembly over the reamer onto the resected proximal tibia to confirm the A/P and M/L size. Adjust by selecting a different **Tibial Sizing Template** if needed.

Slide the **Tibial Neutral Bushing** onto the reamer. To confirm alignment, insert the **Alignment Rod** into the handle. If adequate coverage and position is not achieved, refer to the Offset Tibial Trial Preparation step. If adequate coverage and position is achieved, proceed to the next step.



Instruments



Tibial Sizing Template



Tibial Sizing Template Handle



Tibial Neutral Bushing



Alignment Rod

# D. Non Offset Tibial Preparation

Choose the **Reamer Guide Rod** corresponding to the diameter of the last **Straight Stem Reamer** used. Attach the **Reamer Guide Rod** to the **Boss Reamer**.

Ream until the depth reaches to the laser marked "T" on the **Boss Reamer**.

**Note:**

If the last reamer used was larger than 16 mm, the boss reaming process will not be necessary.

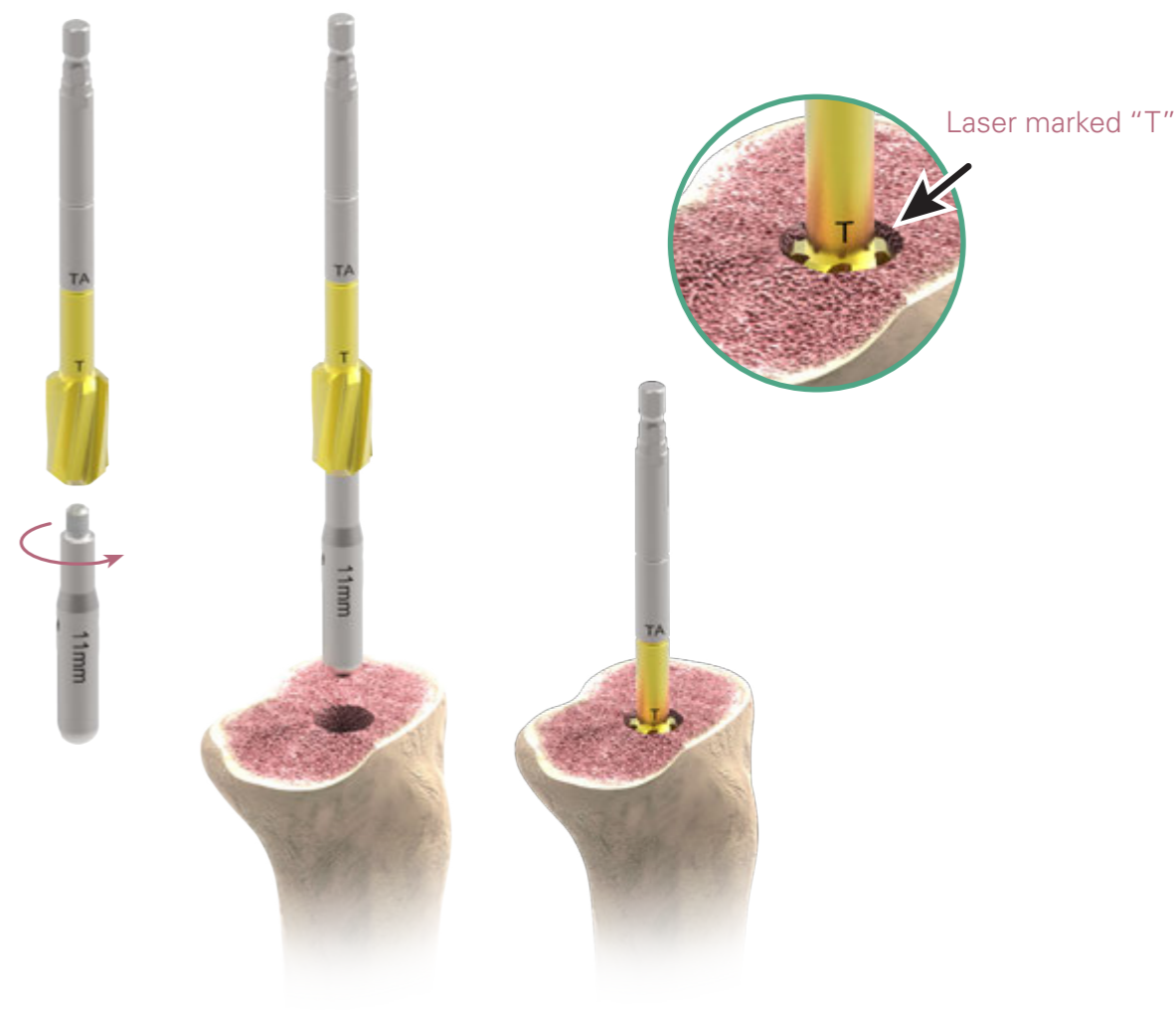

Instruments



Reamer Guide Rod



Boss Reamer

# D. Non Offset Tibial Preparation

Assemble the tibial trial by pushing the appropriate size **Straight Stem Trial** into the selected **Tibial Baseplate Trial** through the bayonet locking mechanism.

Insert the tibial trial assembly into the tibial canal.



Instruments



Straight Stem Trial



Tibial Baseplate Trial

# E. Offset Tibial Preparation

If the position of the **Tibial Sizing Template** is not satisfactory, offset tibial trial preparation can be performed. Insert the 2 mm or 4 mm **Tibial Offset Bushing** onto the reamer and use the **Offset Bushing Wrench** to rotate it until the proper tibial coverage is achieved. Use the **Alignment Rod** to confirm alignment.

Record the size (2 mm or 4 mm) and number on the **Tibial Offset Bushing** that aligns to the laser mark on the **Tibial Sizing Template** for reference in a future step. (E.g., 5 o'clock position shown above). Make sure the alignment is set to a specific laser mark/position.



5 o'clock direction

Instruments



Tibial Sizing Template



Tibial Sizing Template Handle



Alignment Rod



Tibial Offset Bushing



Offset Bushing Wrench



# E. Offset Tibial Preparation

Secure the **Tibial Sizing Template** with 2 **Round Pins**, then remove the **Tibial Offset Bushing**.

Insert the **Tibial Stem Drill Guide** onto the **Tibial Sizing Template**. Prepare the offset canal by applying the **Tibial Stem Drill** through the guide until a positive stop is achieved. Remove the tibial instrument assembly.

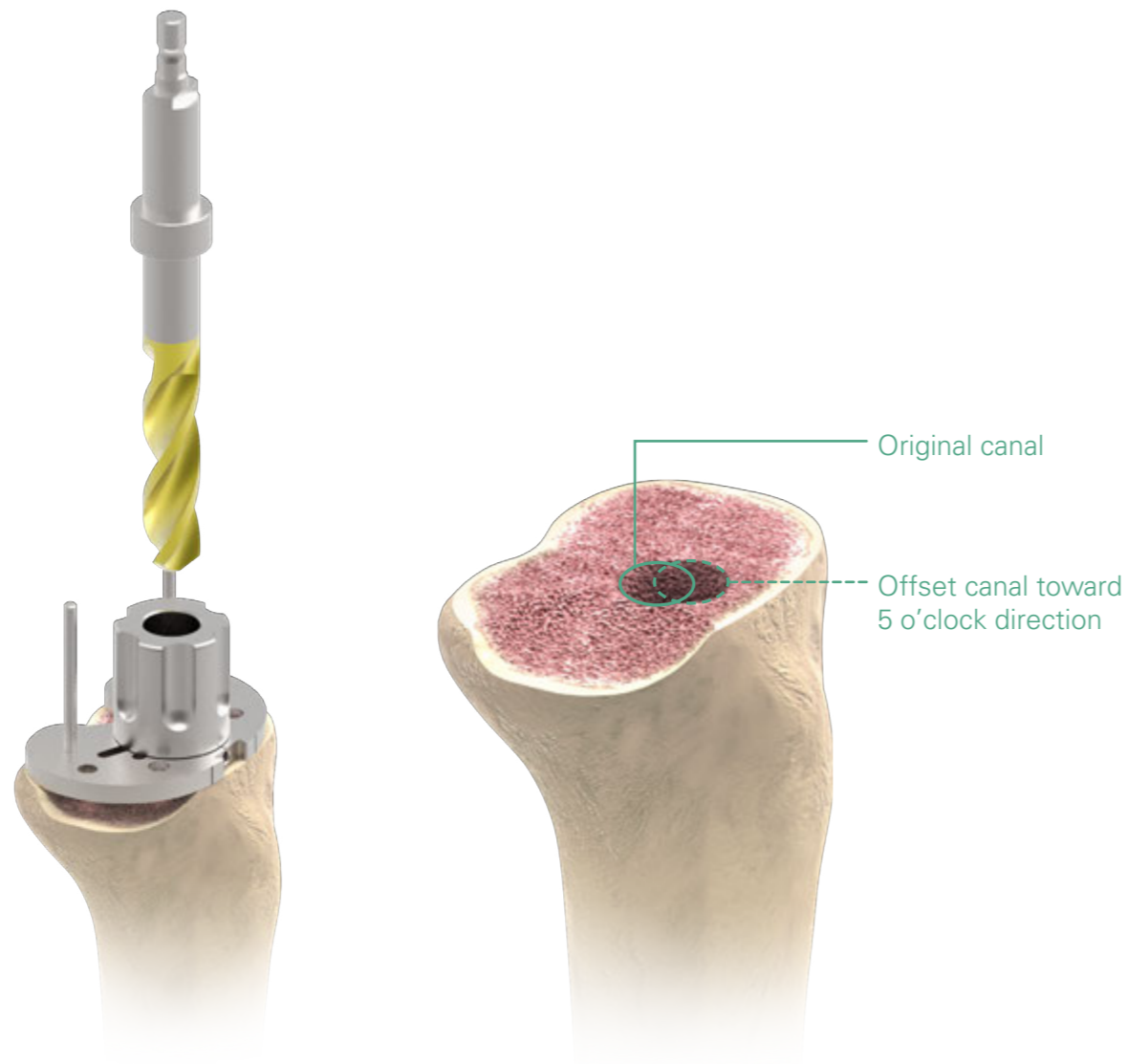

Instruments



# E. Offset Tibial Preparation

Assemble the **Screw Driver Adapter** to the **Driver Handle**, then utilize it to loosen the **Offset Adapter Trial**.

Align the indicator on the **Offset Adapter Trial** to the number previously identified, then retighten the trial.



Instruments



## E. Offset Tibial Preparation

Connect either the 2 mm or 4 mm **Offset Adapter Trial** that corresponds to the **Tibial Offset Bushing** previously selected to the **Tibial Baseplate Trial** through the bayonet-style locking assembly, then ensure the correct laser mark on the **Offset Adapter Trial** is aligned to the corresponding marking on the **Tibial Baseplate Trial**.

Attach the trial assembly to the appropriate **Straight Stem Trial**. Insert the tibial trial assembly into the tibial canal.



Instruments



Straight Stem Trial Tibial Baseplate Trial Offset Adapter Trial

## F. Femoral Canal Preparation

Progressively ream the femoral Intramedullary (IM) canal starting with the smallest diameter **Straight Stem Reamer** and gradually increasing the reamer diameter (9 mm to 24 mm in 1 mm increments) until the appropriate diameter and depth is achieved as indicated on the etched markings on the reamers.

Note the diameter and length reamed of the final reamer used for reference in a future step.

**Note:**

- F : Femoral Component with the Stem
- FA : Femoral Component with Stem + Adapter

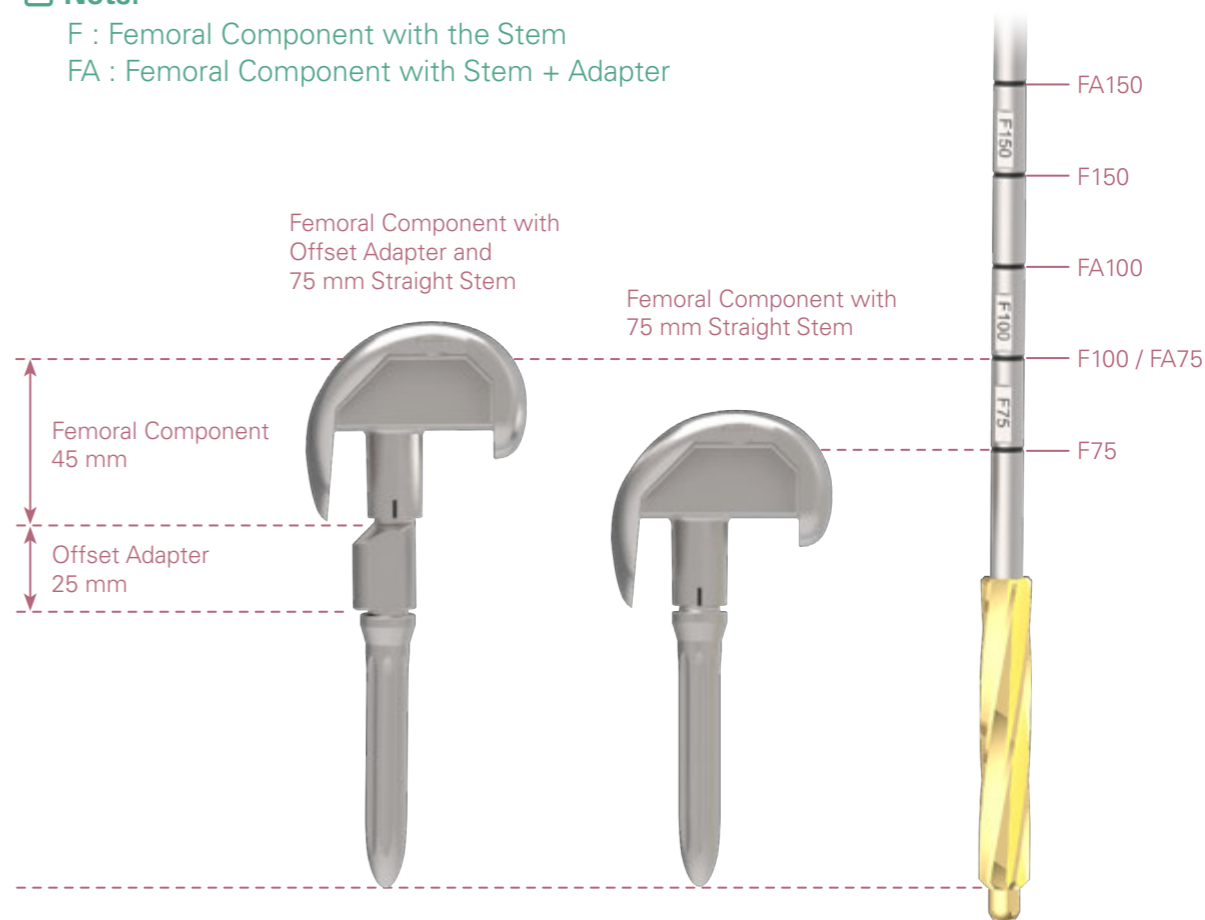

Instruments



Straight Stem Reamer

# F. Femoral Canal Preparation

Choose the **Reamer Guide Rod** corresponding to the diameter of the last reamer used. Attach the **Reamer Guide Rod** to the **Boss Reamer**.

Ream the femoral canal until the indicator mark "F" on the **Boss Reamer** lines up with the entry hole. Note if the last reamer used was larger than 16 mm, the boss reaming process will not be necessary.

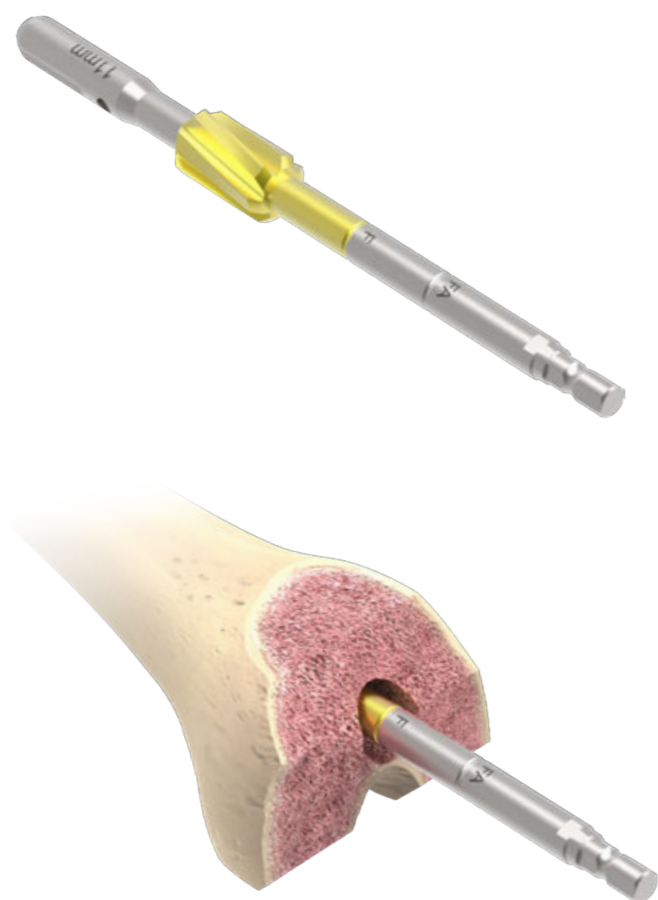

Instruments



Reamer Guide Rod    Boss Reamer    Femoral IM Rod

# G. Distal Femoral Preparation

Place the appropriate **Straight Stem Reamer** (or the **Femoral IM Rod**) into the reamed femoral IM canal.

Attach the **Distal Femoral Plate** to the **Femoral IM Alignment Guide** and slide the assembly onto the reamer until it is positioned against the distal femur. Note the U2 PSA knee **Femoral IM Alignment Guide** offers a fixed 6 degrees valgus angle.

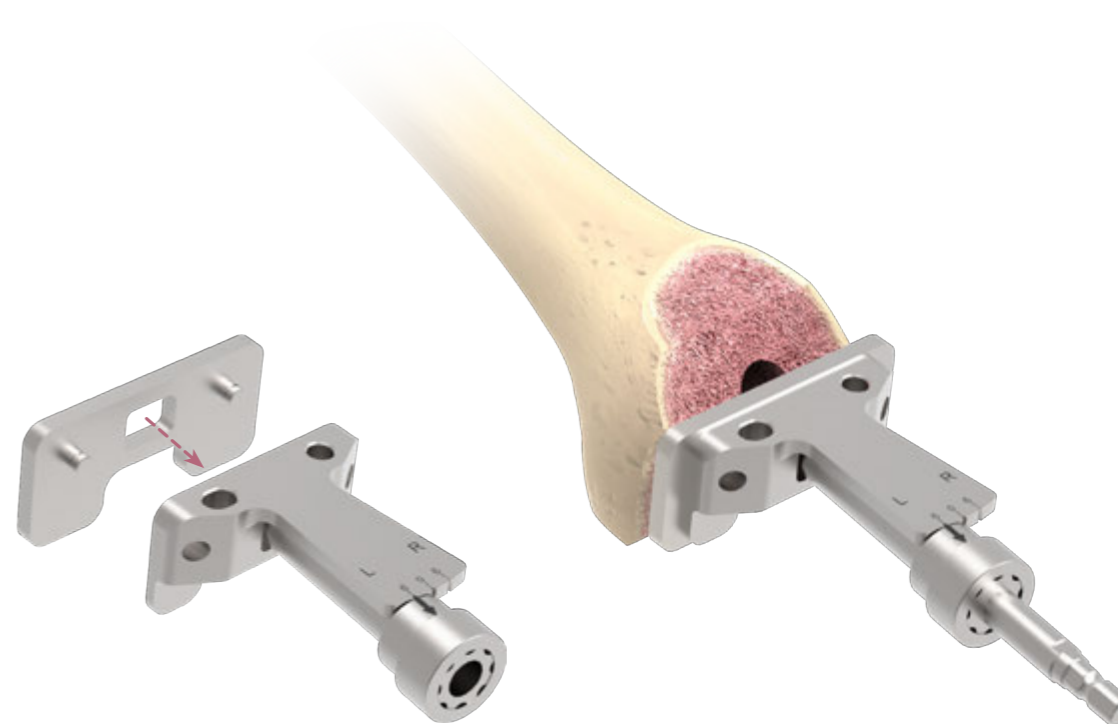

Instruments

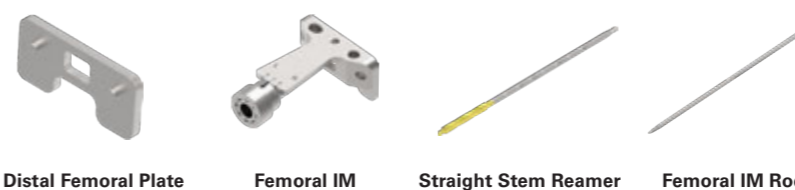

Distal Femoral Plate    Femoral IM Alignment Guide    Straight Stem Reamer    Femoral IM Rod

# G. Distal Femoral Preparation

Attach the **Distal Femoral Alignment Guide** to the **Distal Femoral Resection Guide**, then slide the assembly onto the **Femoral IM Alignment Guide**.

Secure the **Distal Femoral Resection Guide** using 2 **Round Pins** secured in the parallel central zero holes marked '0'. Secure with additional **Round Pins** in the angled pin holes as needed for additional stability prior to resecting.

Remove the alignment guide assembly from the reamer. Perform a 2 mm resection through the "N" slot on the **Distal Femoral Resection Guide**.

**Note:** If adjustment for the resection is needed, utilize the +2 mm or +4 mm holes to relocate the **Distal Femoral Resection Guide** accordingly.

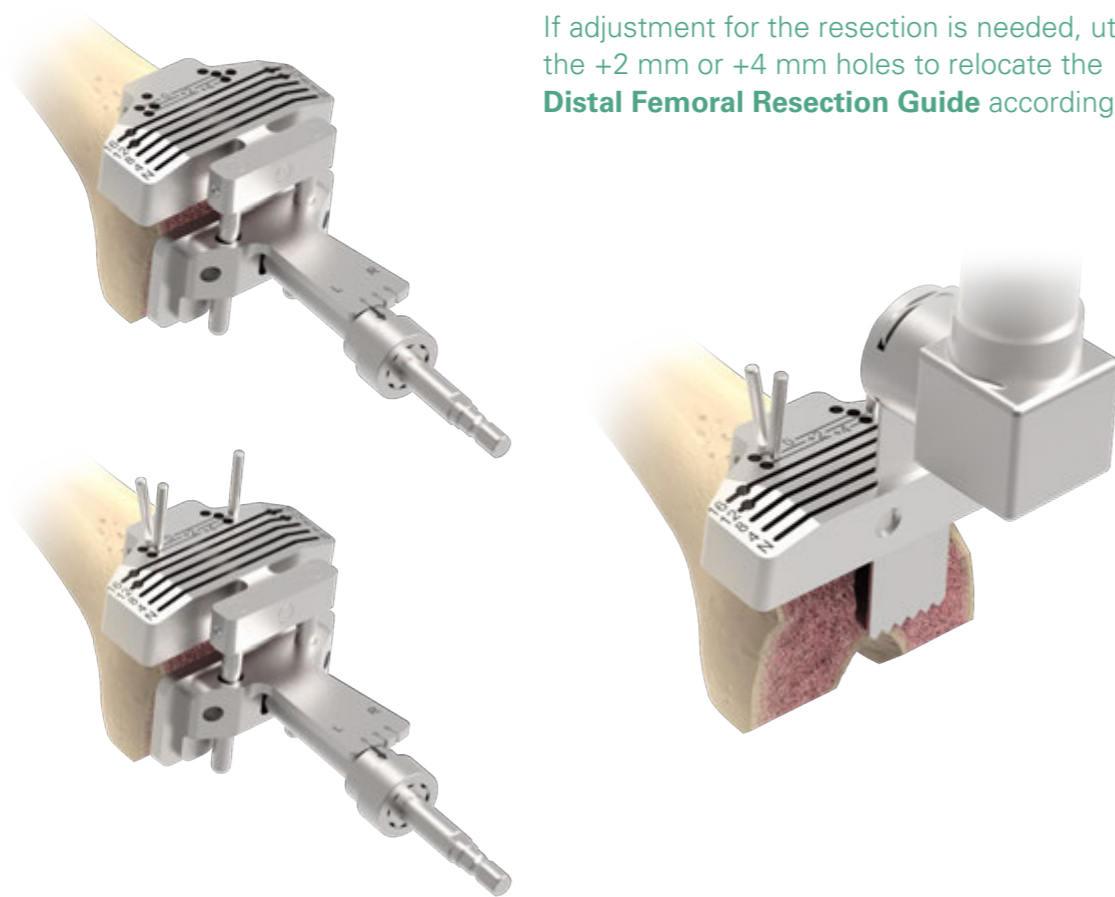

Instruments

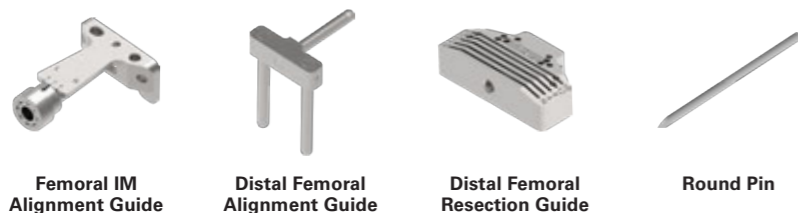

Femoral IM Alignment Guide

Distal Femoral Alignment Guide

Distal Femoral Resection Guide

Round Pin

# H. Non Offset Femoral Preparation

Assemble the correct **Femoral Valgus Adapter**, either "Left" or "Right" to the selected size **Straight Stem Trial**.

Insert the **Femoral Valgus Adapter** onto the **Femoral Sizing Template** and depress it until fully engaged to the sizing template.

Connect the **Screw Driver Adapter** to the **Driver Handle**, then secure the **Femoral Valgus Adapter** and **Femoral Sizing Template** assembly.



Instruments



Straight Stem Trial

Screw Driver Adapter

Driver Handle

Femoral Valgus Adapter

Femoral Sizing Template

# H.Non Offset Femoral Preparation

Insert the femoral sizing assembly into the canal and assess proper A/P and M/L size and position in relation to the femur.

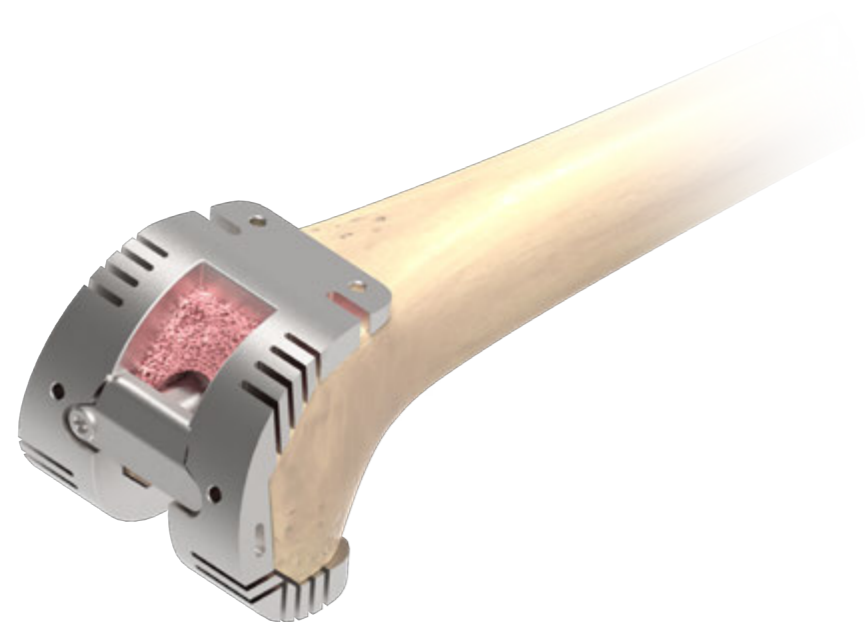

Instruments



Straight Stem Trial



Femoral Valgus Adapter



Femoral Sizing Template

# H.Non Offset Femoral Preparation

Set the final A/P and M/L position of the femoral sizing assembly then place the selected **Tibial Spacer Base** on the tibial baseplate assembly with the appropriate thickness **Tibial Spacer**.

Evaluate joint stability using the selected trial components. Switch to different **Tibial Spacer** trial thicknesses as needed to obtain optimal stability. If the femoral sizing assembly does not contact the distal end of the femur during the evaluation, a **Femoral Distal Spacer** can be utilized as a temporary augment.

After restore an appropriate joint line, balance the extension and flexion gaps.

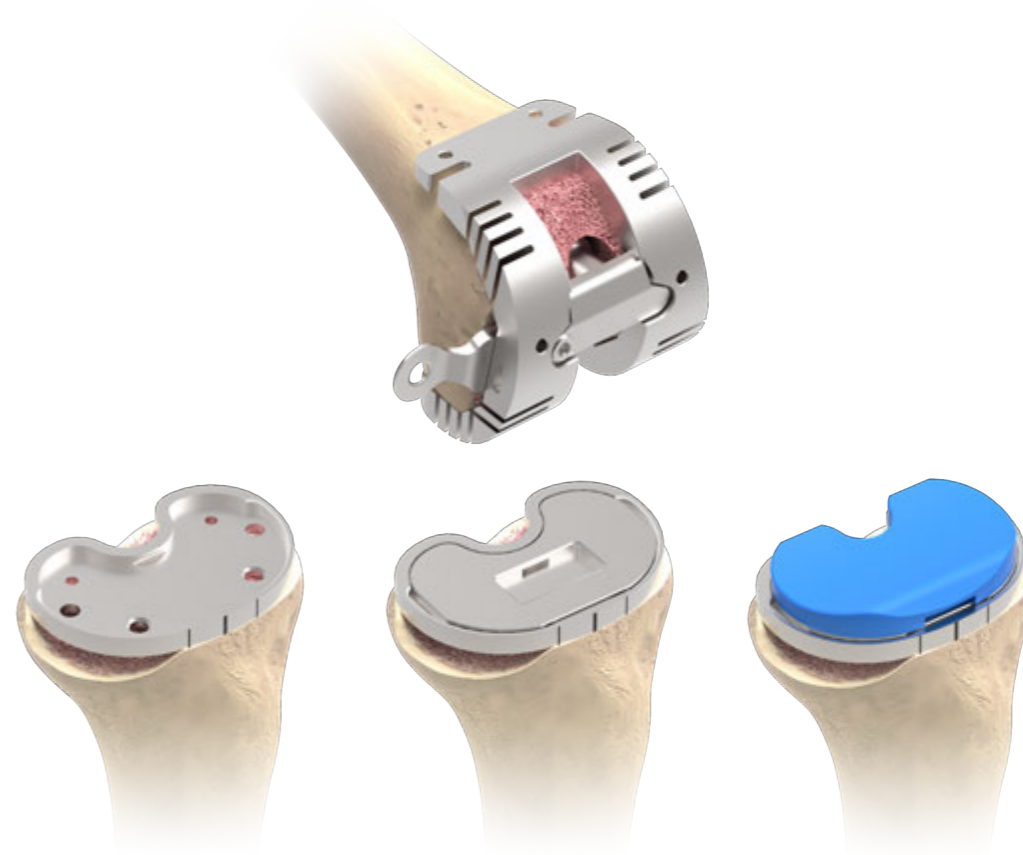

Instruments



Femoral Valgus Adapter



Femoral Sizing Template



Tibial Spacer Base

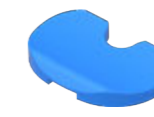

Tibial Spacer



Femoral Distal Spacer

# H.Non Offset Femoral Preparation

Once the joint line has been determined, secure the **Femoral Sizing Template** with a **Round Pin** on the anterior portion of the template. Attach the **Femoral Rotation Guide** to the **Resection Check Blade** by inserting the guide into the slots on the template.

Use the **Resection Check Blade** to align the assembly with the transepicondylar axis and achieve proper rotation. Adjust position of the assembly if needed. Once the **Femoral Sizing Template** is in proper alignment and rotation, secure in place with 2 **Round Pins** in the upper two holes.

Once the joint line and femoral rotation is confirmed, additional bone resection for femoral augments can be performed if needed. Space for femoral augments is prepared by performing resections through 4/8/12/16 mm resection slots on the **Femoral Sizing Template** that match the available femoral augment implant options.

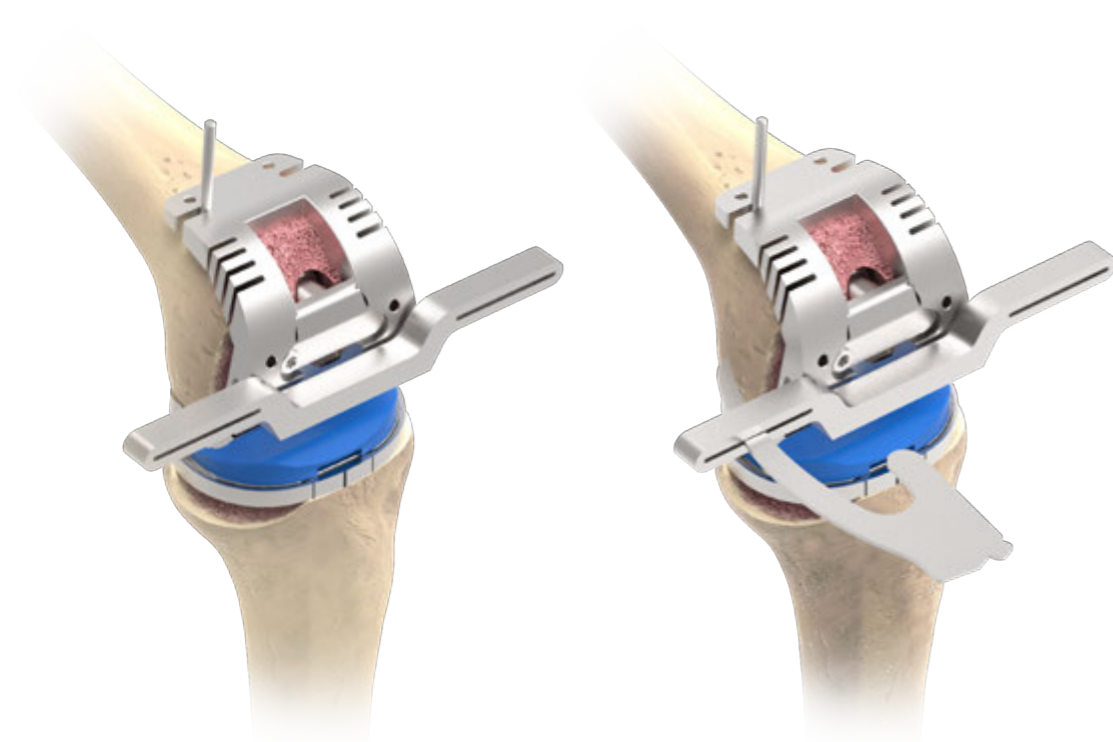

Instruments

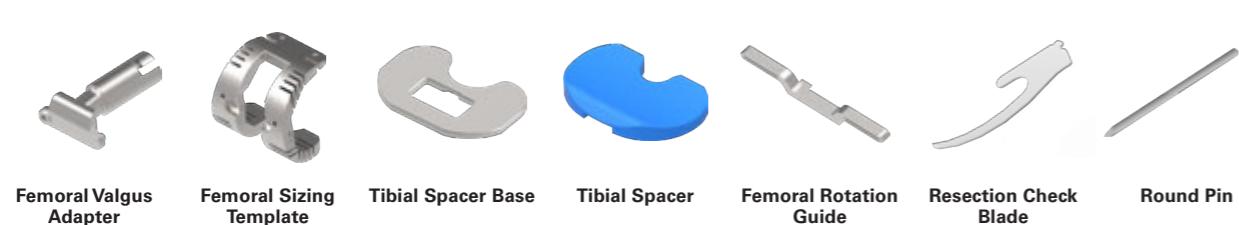

# H.Non Offset Femoral Preparation

Disassemble the **Femoral Valgus Adapter** and the **Femoral Sizing Template** with the **Screwdriver**.

Utilize the **Sliding Hammer** together with the **Valgus Adapter Remover** to remove the **Femoral Valgus Adapter** and the **Stem Trial**, leaving the **Femoral Sizing Template** in position. Then complete the preliminary intercondylar box resection by resecting the sides and distal 'top' portion of the **Femoral Sizing Template**. Remove the **Femoral Sizing Template**.

**Note:** Select the appropriate width saw blade prior to intercondylar box resection.

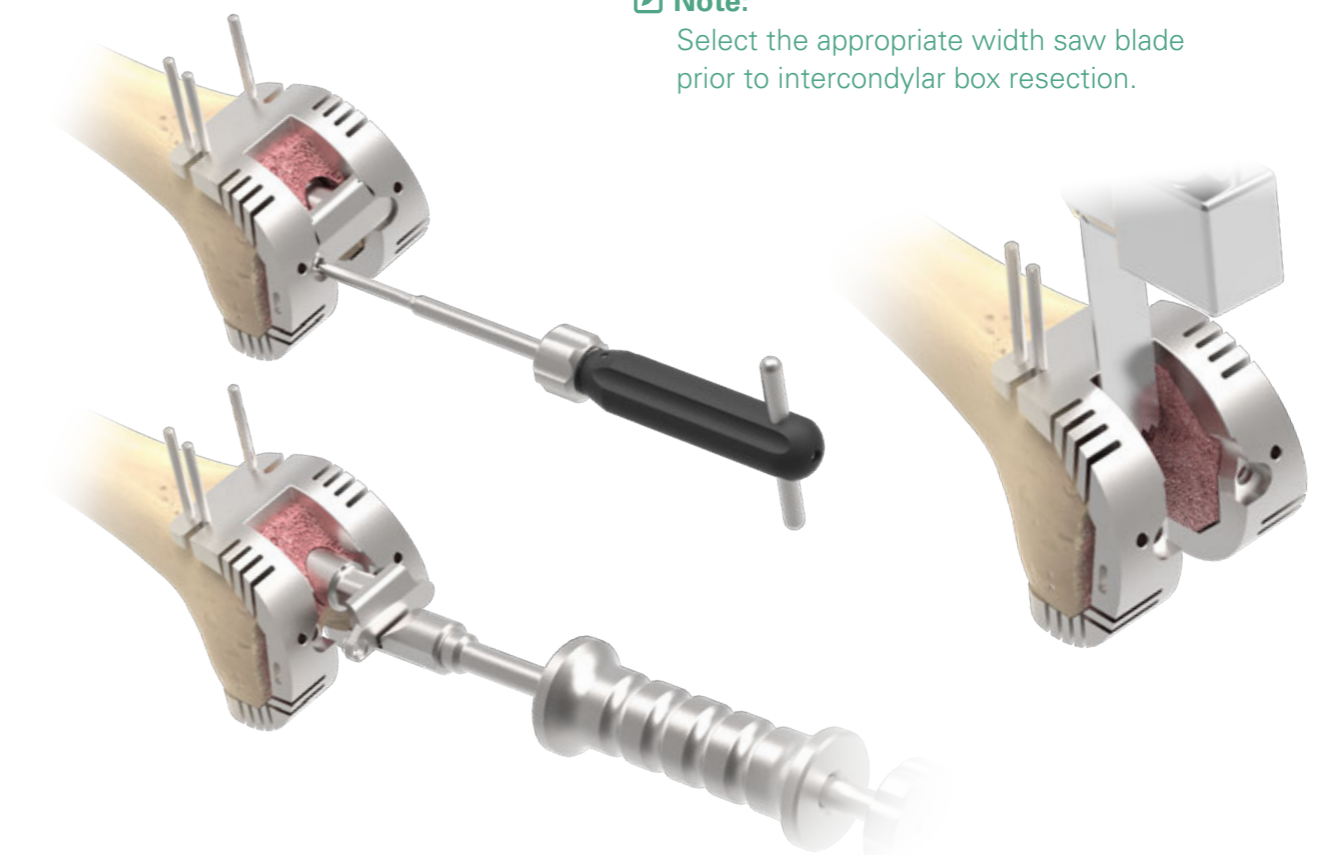

Instruments

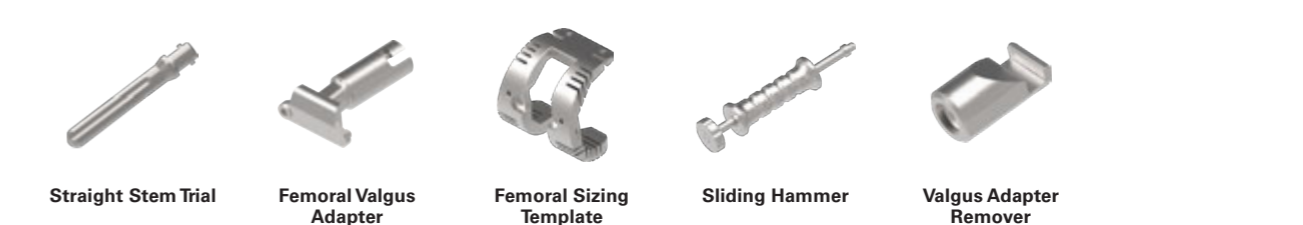

# I. Offset Femoral Preparation

Insert the final diameter **Straight Stem Reamer** previously used into the femoral canal. Select the optimal size **Femoral Resection Guide** and insert over the **Straight Stem Reamer** and against the surface of distal femur.

Slide the **Femoral Offset Adapter** over the **Straight Stem Reamer** into the **Femoral Resection Guide** and set the position for the left or right knee as noted on the indicator knob.

**Note:**

The **Femoral Resection Guide** can be stabilized on the distal femur by assembling the **Distal Spacer** through the backside groove of the **Femoral Resection Guide**.

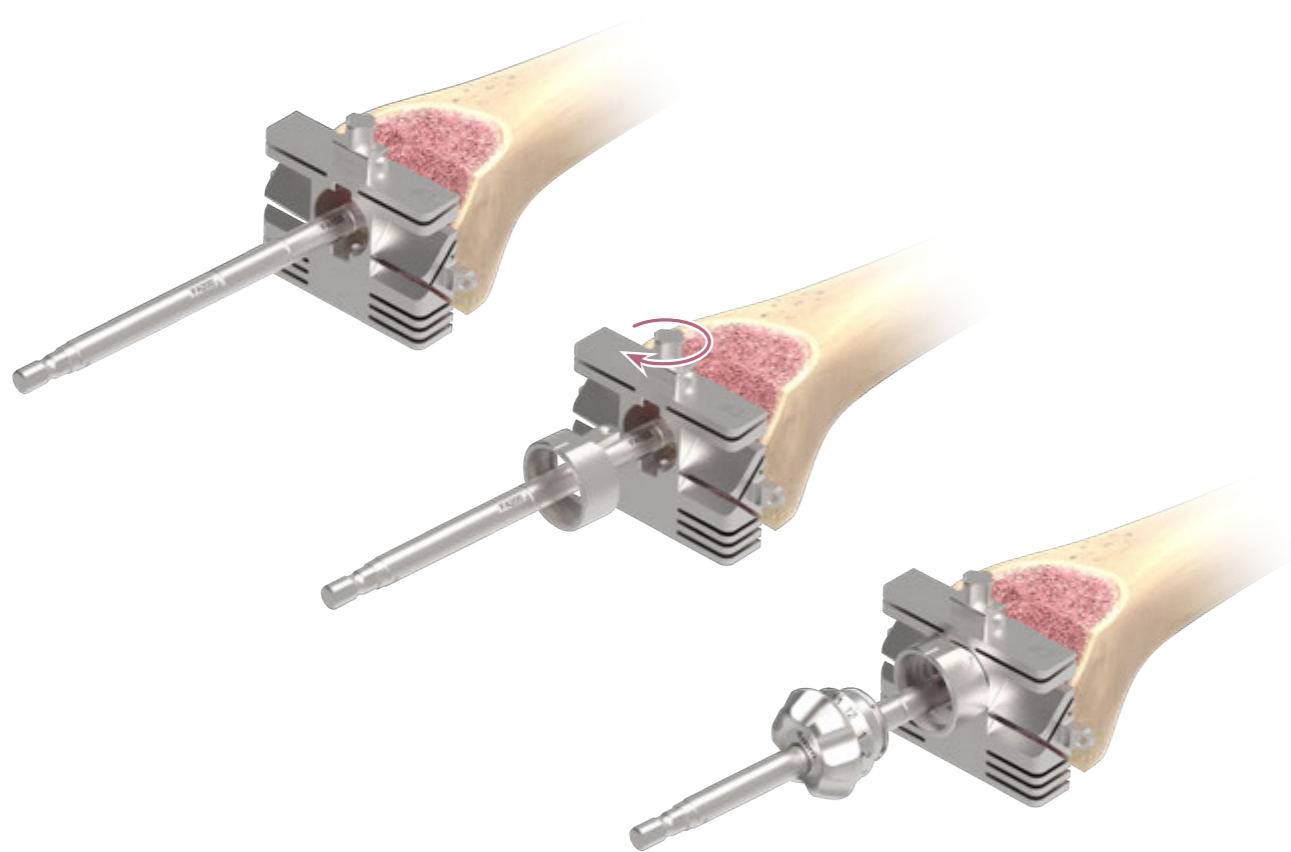

Instruments



Straight Stem Reamer    Femoral Resection Guide    Femoral Offset Adapter    Femoral Offset Bushing    Distal Spacer

# I. Offset Femoral Preparation

Rotate the **Femoral Offset Bushing** until the **Femoral Resection Guide** is positioned appropriately to optimize medial and lateral coverage as well as anterior and posterior bone resection. The resection level can be confirmed using the **Resection Check Blade**.

Once in the optimal position, secure the **Femoral Resection Guide** to the distal femur with 2 **Round Pins**. Complete the anterior, posterior and chamfer resections.

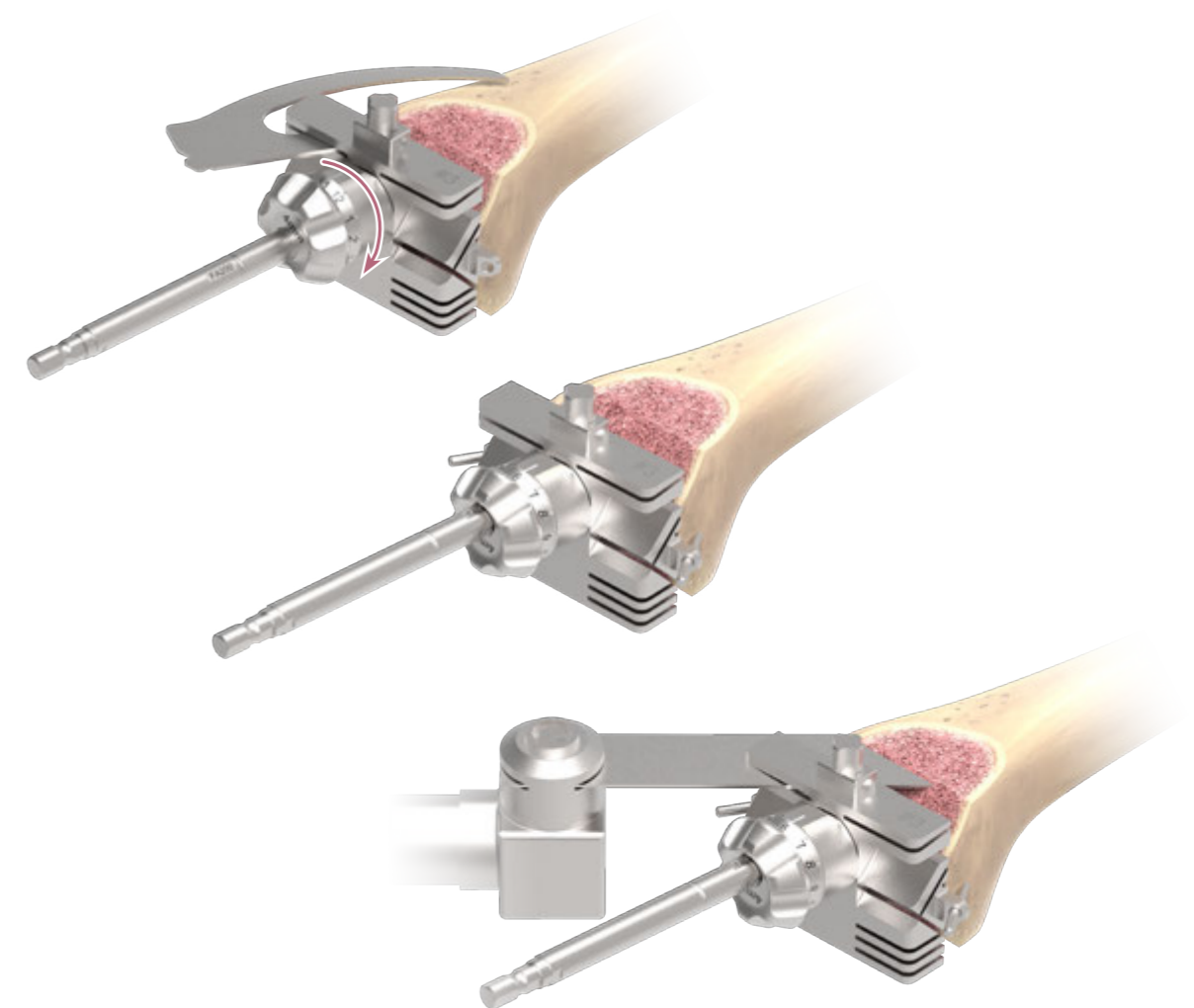

Instruments



Straight Stem Reamer    Femoral Resection Guide    Femoral Offset Adapter    Femoral Offset Bushing    Resection Check Blade    Round Pin

# I. Offset Femoral Preparation

Place the **Box Cutting Plate** on the anterior of the femur and secure to the **Femoral Resection Guide** using the **Screwdriver**. Secure the **Box Cutting Plate** on the medial side of anterior femur with a **Round Pin** to enhance fixation.

Advance the **PS Notch Punch** into the **Box Cutting Plate** until a positive stop is achieved.



Instruments



Femoral Resection Guide    Femoral Offset Adapter    Femoral Offset Bushing    Box Cutting Plate    Screw Driver Adapter    Driver Handle    PS Notch Punch

# I. Offset Femoral Preparation

Remove the **Femoral Offset Bushing** and replace with the **Femoral Offset Drill Guide**, then position against the **Femoral Resection Guide**.

Advance the 16 mm **Straight Stem Reamer** into the **Femoral Offset Drill Guide/Femoral Offset Cutting Guide** assembly until the distal line marked "F 75" is aligned with the outside of the **Femoral Offset Drill Guide**.

Remove the assembly from the distal femur. Complete the final intercondylar box resection by resecting the sides and distal 'top' portion of the **Box Cutting Plate**, removing any residual bone.

**Note:**  
Select the appropriate width saw blade prior to intercondylar box resection.

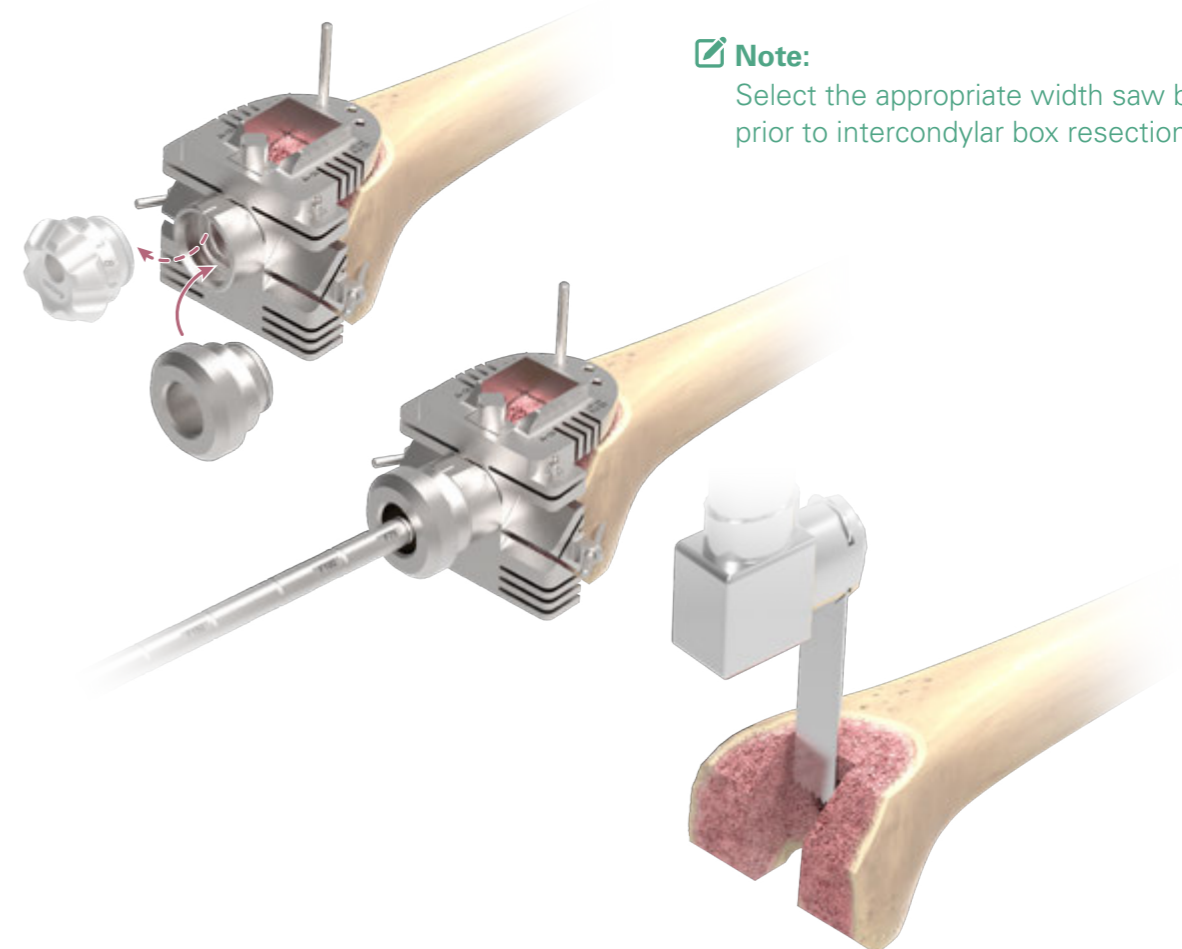

Instruments



Straight Stem Reamer    Femoral Resection Guide    Femoral Offset Adapter    Femoral Offset Drill Guide    Pin    Box Cutting Plate



# J.Trial Reduction

Attach any selected **Femoral Posterior Augment Trials** and **Femoral Distal Augment Trials** to the selected **Femoral Trial** by snapping into place.

Assemble the **Femoral Trial** to the **Straight Stem Trial** and the **Offset Adapter Trial**, if selected.



Instruments



Straight Stem Trial    Offset Adapter Trial    Femoral Posterior Augment Trial    Femoral Distal Augment Trial    Femoral Distal Augment Trial    Femoral Trial

# J.Trial Reduction

Remove the **Tibial Spacer Base** and **Tibial Spacer** from the **Tibial Baseplate Trial**. With the tibial trial assembly in the tibia and the femoral trial assembly in the femur, insert the appropriate size **Tibial Insert Trial**.

Perform a trial reduction and mark the anterior of the tibia using the three anterior laser marks on the **Tibial Baseplate Trial** as a reference for a future technique step.

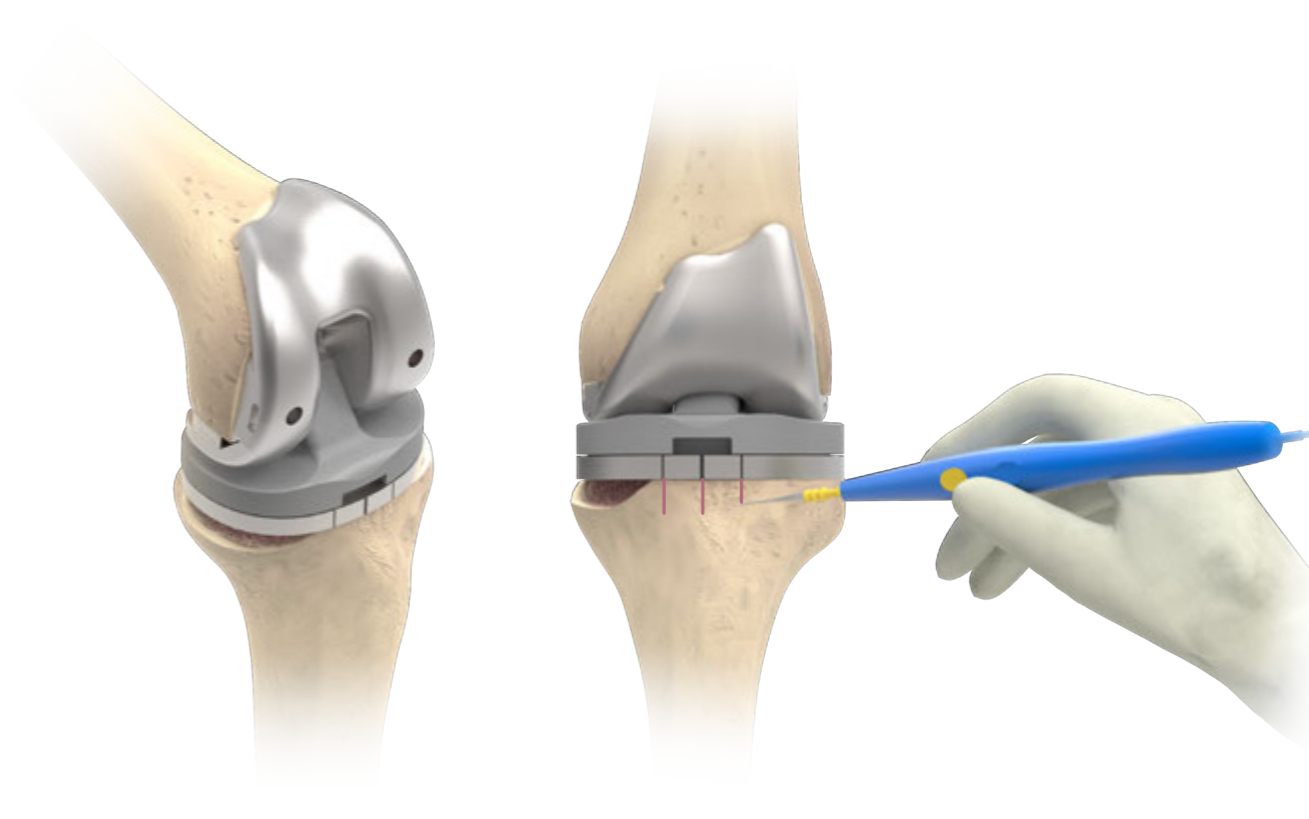

Instruments



Tibial Baseplate Trial    Tibial Spacer Base    Tibial Spacer    Tibial Insert Trial

# K. Final Tibial Preparation

Remove the **Tibial Insert Trial**, taking care to maintain the **Tibial Baseplate Trial** in position by confirming its position using the three anterior laser marks vs. the markings created on the anterior of the tibia.

Insert two **Round Pins** through posterior holes on the **Tibial Baseplate Trial**, then remove the trial.

Place the proper **Tibial Sizing Template** on the proximal tibial surface through the two **Round Pins**. If no tibial augments are needed, proceed to assembling the tibial keel punch.

If tibial augments are needed, confirm the laser marks on the sizing template align to the marks on the anterior tibia. Attach the **Tibial Augment Alignment Sleeve** on the top of the template. Reposition the tibial resection assembly and fix it with two **Round Pins** to the anterior of the tibia.

Remove the template, sleeve and alignment guide, leaving the **Tibial Resection Guide** in place. Space for tibial augments can be prepared by performing resections through 5/10/15 mm resection slots on the **Tibial Resection Guide** that match the available tibial augment implant options.

Remove the tibial instrument assembly after the resection is performed.

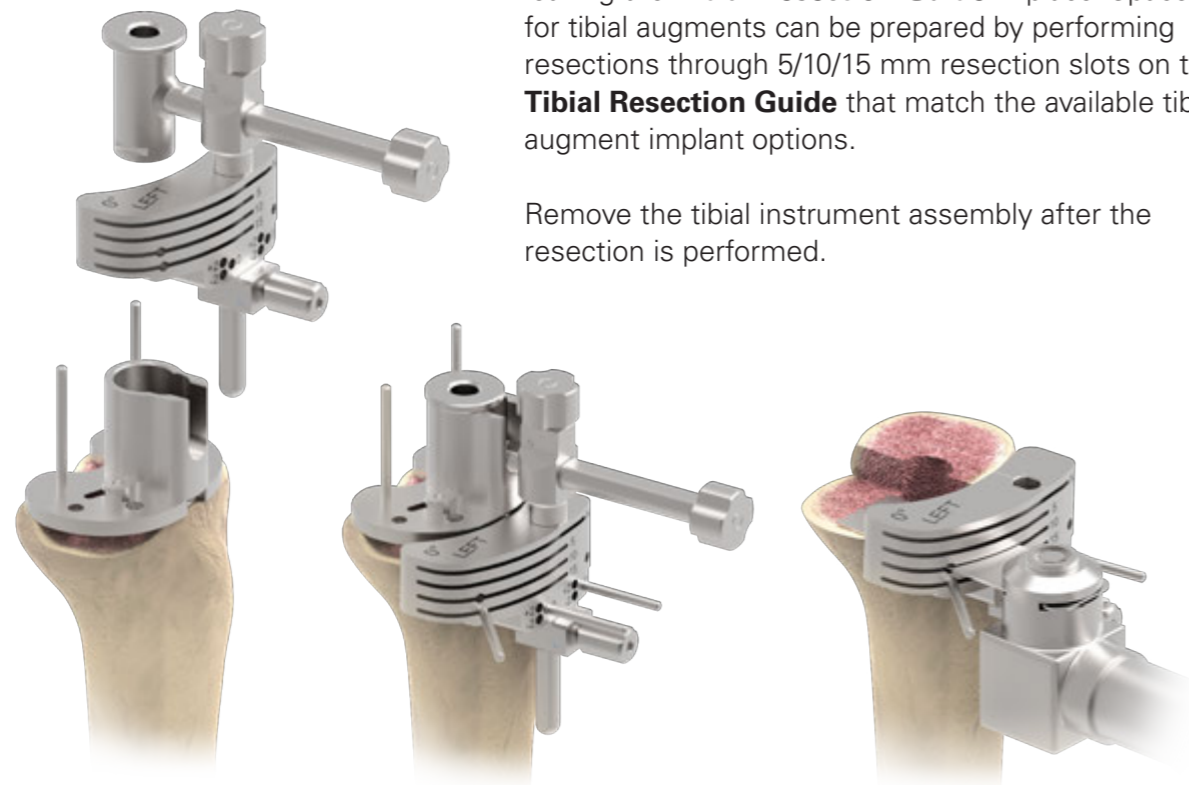

Instruments



Tibial Sizing Template Tibial IM Alignment Guide Tibial Resection Guide Round Pin Tibial Augment Alignment Sleeve

# K. Final Tibial Preparation

If applicable, attach the **Tibial Augment Trial** that corresponds to the completed tibial augment resection to the underneath surface of the selected **Tibial Sizing Template**. Position the selected **Tibial Sizing Template** onto the resected tibial surface and secure with two **Round Pins**.

Assemble the proper size **Tibial Punch** with the **Tibial Punch Handle**, then insert the punch into the **Tibial Sizing Template** and impact until fully seated.

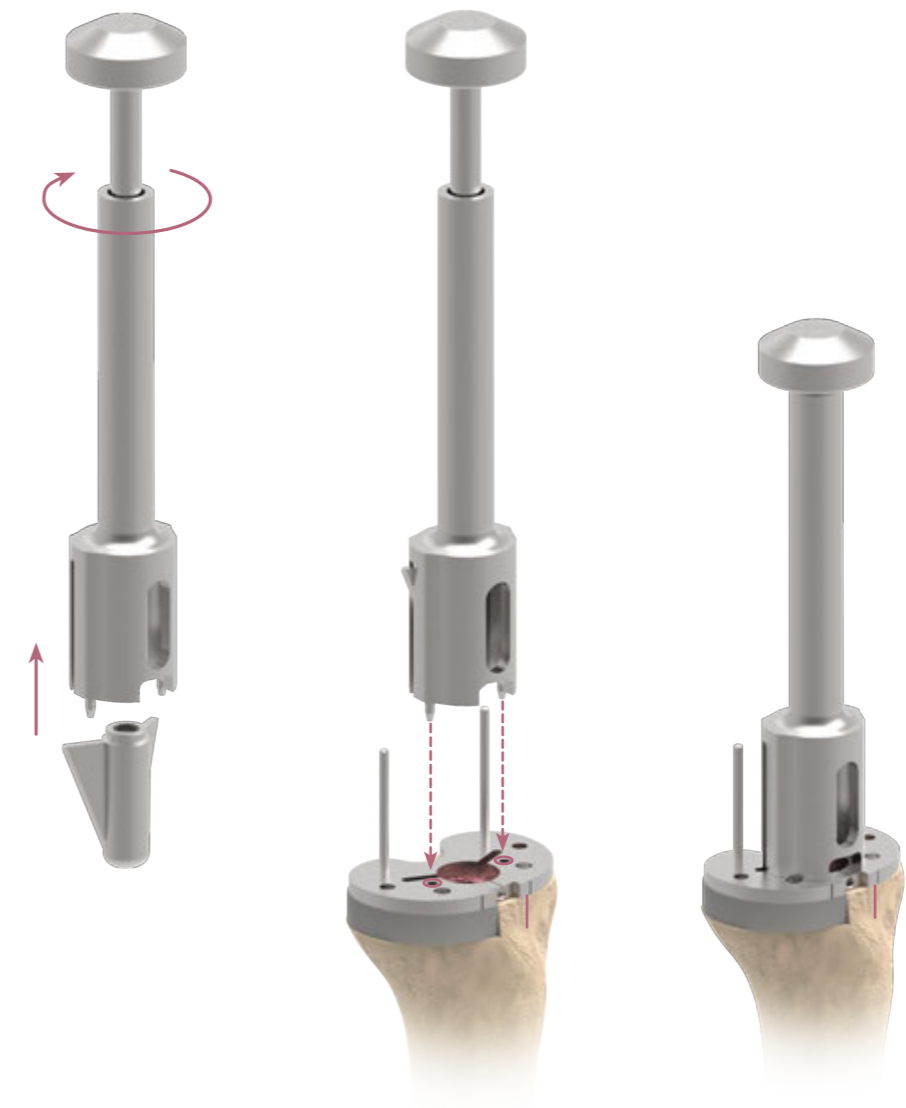

Instruments



Tibial Sizing Template Tibial Augment Trials Tibial Punch Handle Tibial Punch

# L. Final Trial Reduction

Assemble the appropriate **Tibial Baseplate Trial**, **Straight Stem Trial**, **Tibial Augment Trial**, and/or **Offset Adapter Trial** that corresponds to the prepared tibial surface. Insert the final tibial trial assembly onto the tibia then insert the selected **Tibial Insert Trial**.

Evaluate joint stability using the selected trial components. Switch to different **Tibial Insert Trial** thicknesses as needed to obtain optimal stability.

When final position is established, remove the trial implant components. Keep the femoral and tibial trial assemblies complete to use as a reference through the end of the case.



Instruments



Straight Stem Trial Tibial Baseplate Trial Offset Adapter Trial Tibial Insert Trial Tibial Augment Trials

# M. Implantation

If a tibial offset adapter is selected, set the **Tibial Offset Fixture** on the tibial baseplate implant and hold the adapter with **Tibial Offset Wrench** positioned to the number that was established previously in the Offset Tibial Trial Preparation section.

Place the **Stem Impactor** on the adapter, and impact on the impactor solidly to ensure the taper lock is properly engaged between the adapter and the baseplate implant.

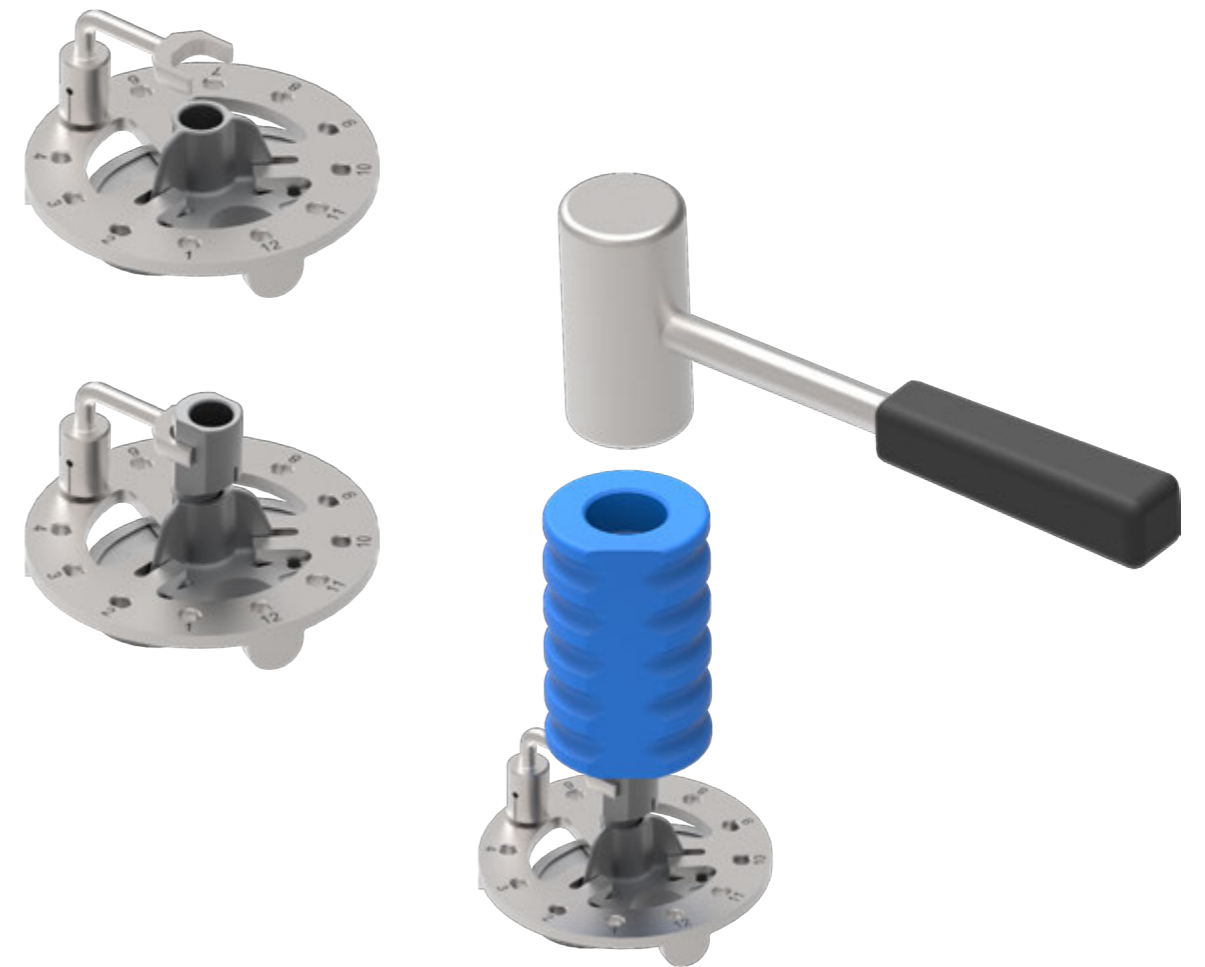

Instruments



Tibial Offset Fixture Tibial Offset Wrench Stem Impactor

# M. Implantation

If selected, screw the appropriate tibial augment(s) into the distal aspect of the tibial baseplate implant with the **Screwdriver**.

Secure the augments by applying moderate torque to tighten the screws until securely tightened by hand.



Instruments



Screw Driver Adapter



Driver Handle

# M. Implantation

Choose the appropriate length and diameter stem corresponding to the final tibial trial assembly.

Insert the stem extension implant into the offset adapter and/or the tibial baseplate implant, then protect the stem by placing the **Stem Impactor** on the tip of the stem.

Impact on the impactor solidly to ensure the taper lock is properly engaged.

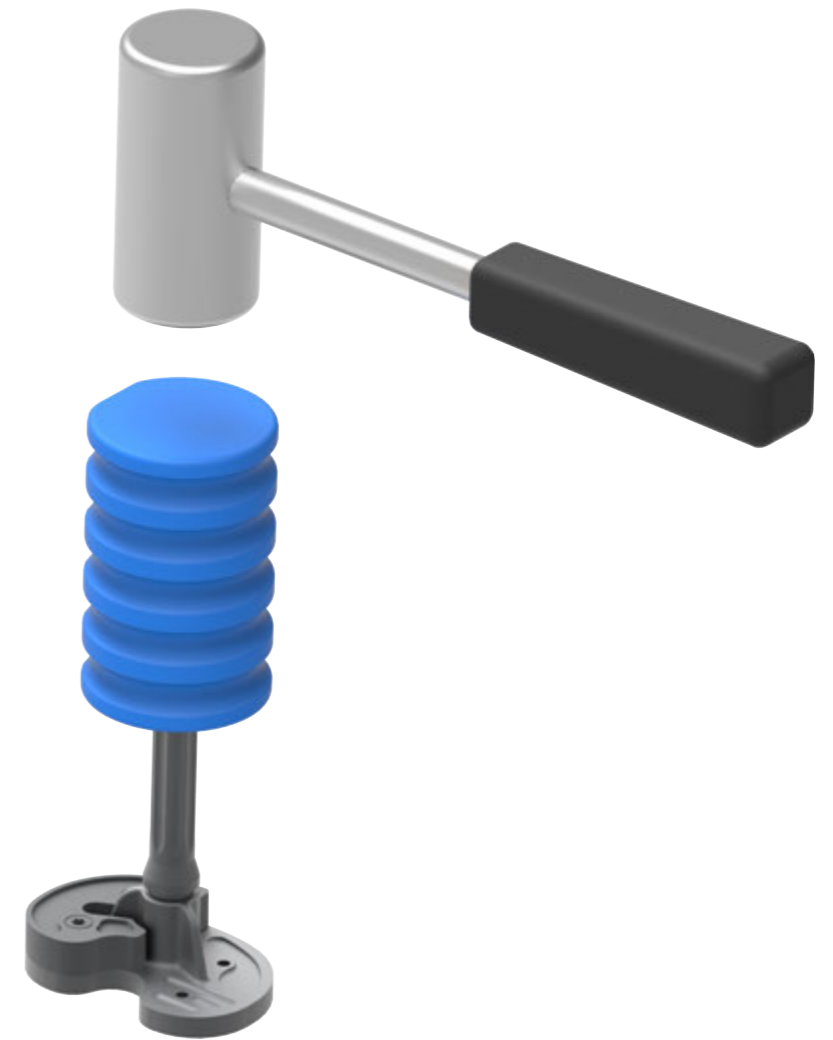

Instruments



Stem Impactor

# M. Implantation

Select the size of femoral component implant and stem corresponding to the final femoral trial assembly.

If femoral distal augments or/and posterior augments are needed, select the appropriate augment implant components and secure to the femoral implant component using the **Screw Driver Adapter / Screw Driver Adapter L** and **Driver Handle** assembly .



Instruments



Screw Driver Adapter    Driver Handle    Screw Driver Adapter L

# M. Implantation

If a femoral offset Adapter is selected, take the Adapter trial as a reference (obtained previously in the Offset Femoral Sizing and Placement section) and align the predetermined clock position on the offset Adapter with the etched line on the posterior side of the femoral component.

Insert the offset Adapter into the femoral implant. Place the **Stem Impactor** on the Adapter and impact to ensure the taper lock is properly engaged

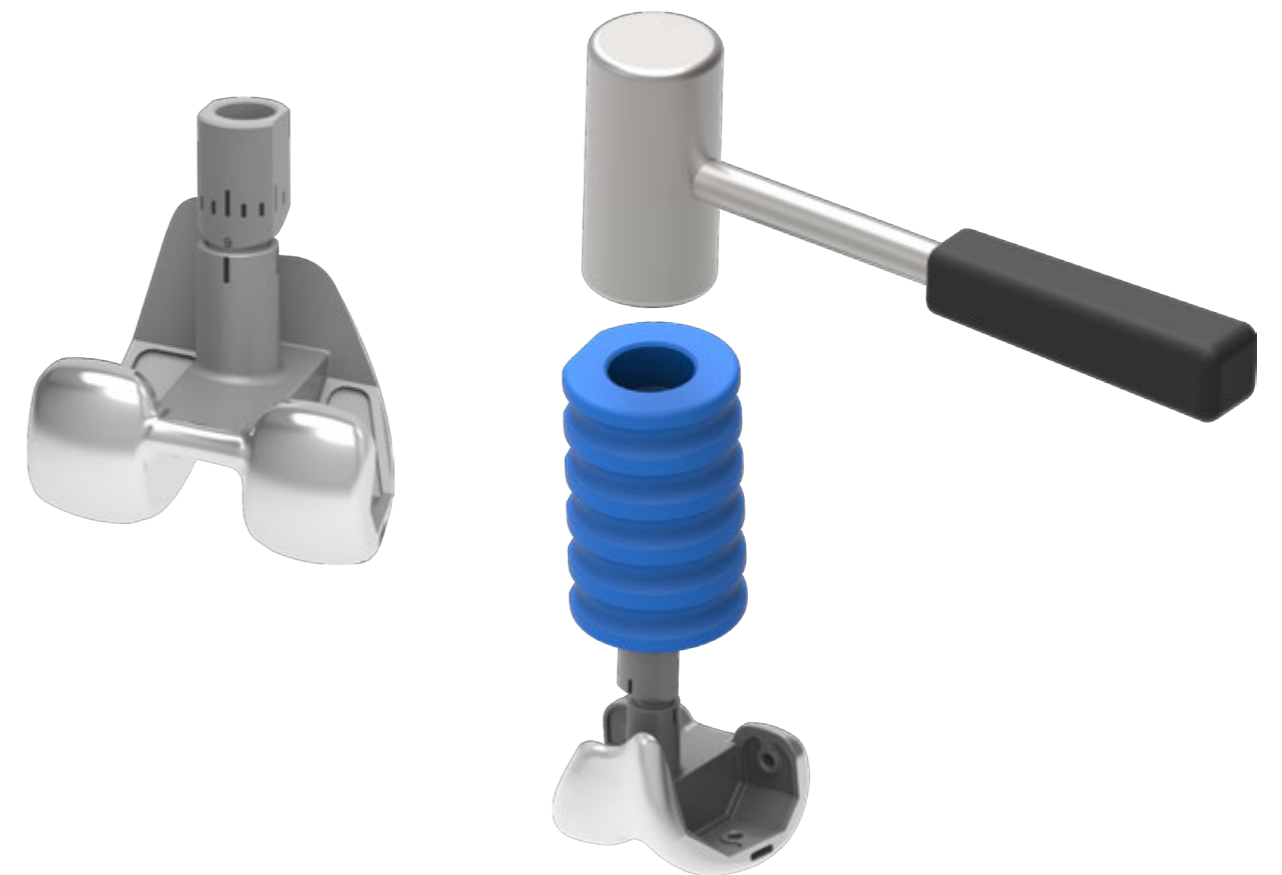

Instruments



Stem Impactor

# M. Implantation

Select the appropriate length and diameter stem implants corresponding to the final femoral trial assembly. Insert the stem extension implant into the offset Adapter and/or femoral component.

Protect the stem by placing the **Stem Impactor** on the tip of the stem, then impact to ensure the taper lock is properly engaged.

After the stem has been impacted into the femoral component, insert the femoral screw into the intercondylar hole on the femoral component using the **Screw Driver Adapter** and **Drive Handle** assembly, applying moderate torque to tighten the screw until securely tightened by hand.



Instruments



Screw Driver Adapter



Driver Handle



Stem Impactor

# M. Implantation

Apply cement under the tibial baseplate and insert the tibial implant into the position with the **Tibial Baseplate Driver**.

Impact the tibial baseplate implant with the **Tibial Baseplate Impactor** and remove excess cement.



Instruments



Tibial Baseplate Driver



Tibial Baseplate Impactor

# M. Implantation

Place cement onto the surface of the femoral component and insert the implant into the position with the **Femoral Driver**.

Impact the implant with the **Femoral Impactor** and remove excess cement.

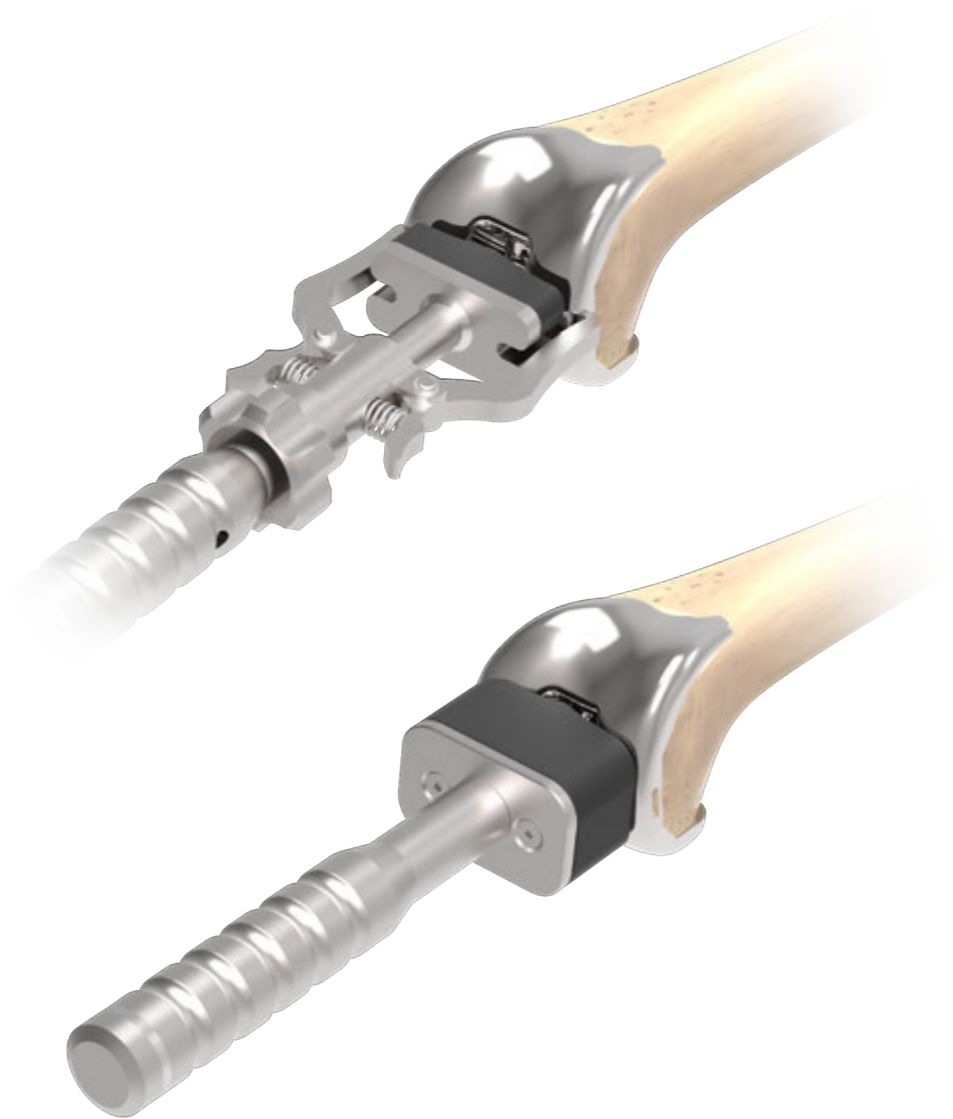

Instruments



Femoral Driver



Femoral Impactor

# M. Implantation

Place the appropriate size tibial insert on the tibial baseplate and use the **Universal Impactor** to fully seat the insert.

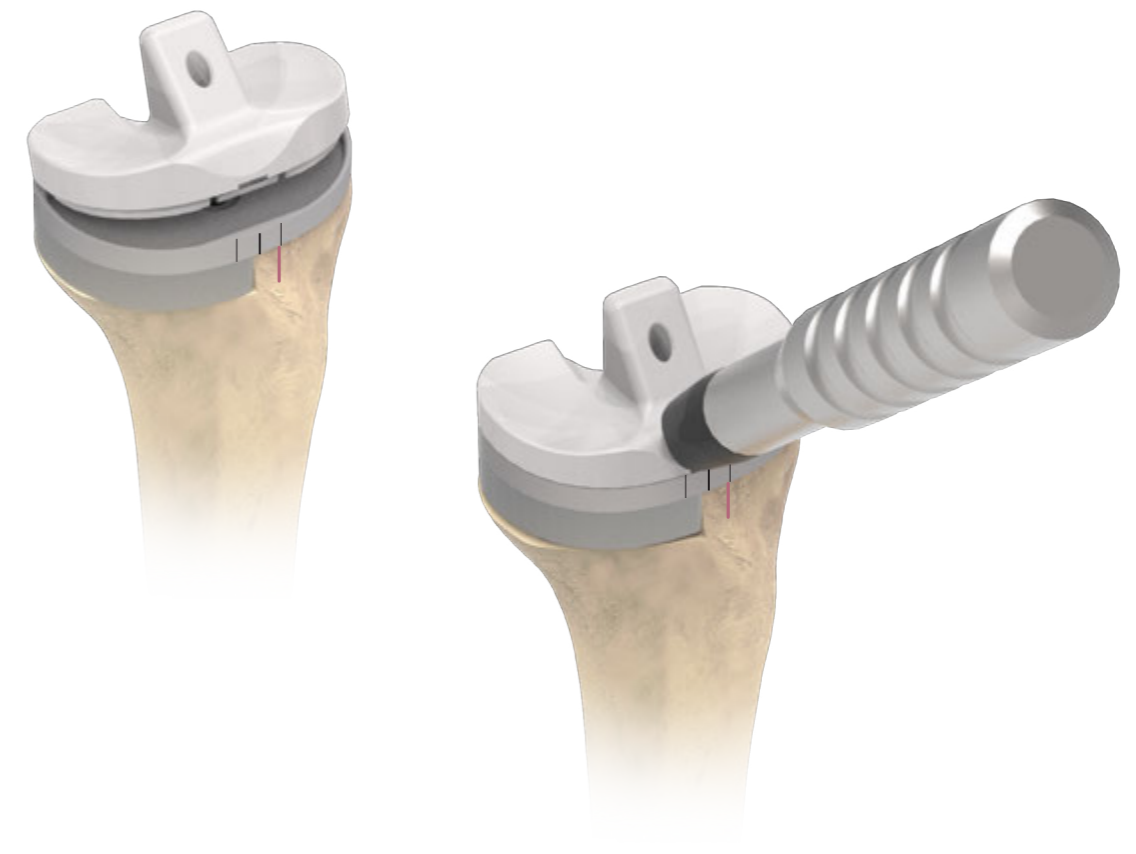

Instruments



Universal Impactor

# M. Implantation

After the tibial insert is emplaced, tighten the screw that is inside the tibial insert using the **Screw Driver Adapter** and **Driver Handle** assembly.



Instruments



Screw Driver Adapter



Driver Handle



# Order Information

## Femoral Component

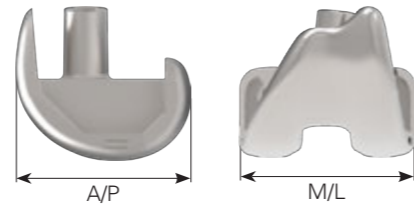

	Left	Right
#1	2103-5110	2103-5210
#2	2103-5120	2103-5220
#3	2103-5130	2103-5230
#4	2103-5140	2103-5240
#5	2103-5150	2103-5250
#6	2103-5160	2103-5260

	A/P	M/L
#1	52	56
#2	56	60
#3	60	64
#4	64	68
#5	68	72
#6	72	76

Unit : mm

## Tibial Baseplate

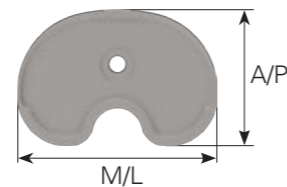

#1	2203-5210
#2	2203-5220
#3	2203-5230
#4	2203-5240
#5	2203-5250
#6	2203-5260

	A/P	M/L
#1	42	63
#2	44.5	66
#3	47	69
#4	49.5	72
#5	52.5	76
#6	55.5	80

Unit : mm

# Order Information

## Tibial Insert

Special Order Items



		UHMWPE							
		9 mm	11 mm	13 mm	15 mm	18 mm	21 mm	25 mm	30 mm
#1	2303-5011	2303-5012	2303-5013	2303-5014	2303-5015	2303-5016	2303-5017	2303-5018	2303-5019
#2	2303-5021	2303-5022	2303-5023	2303-5024	2303-5025	2303-5026	2303-5027	2303-5028	2303-5029
#3	2303-5031	2303-5032	2303-5033	2303-5034	2303-5035	2303-5036	2303-5037	2303-5038	2303-5039
#4	2303-5041	2303-5042	2303-5043	2303-5044	2303-5045	2303-5046	2303-5047	2303-5048	2303-5049
#5	2303-5051	2303-5052	2303-5053	2303-5054	2303-5055	2303-5056	2303-5057	2303-5058	2303-5059
#6	2303-5061	2303-5062	2303-5063	2303-5064	2303-5065	2303-5066	2303-5067	2303-5068	2303-5069

		XPE							
		9 mm	11 mm	13 mm	15 mm	18 mm	21 mm	25 mm	30 mm
#1	2303-5611	2303-5612	2303-5613	2303-5614	2303-5615	2303-5616	2303-5617	2303-5618	2303-5619
#2	2303-5621	2303-5622	2303-5623	2303-5624	2303-5625	2303-5626	2303-5627	2303-5628	2303-5629
#3	2303-5631	2303-5632	2303-5633	2303-5634	2303-5635	2303-5636	2303-5637	2303-5638	2303-5639
#4	2303-5641	2303-5642	2303-5643	2303-5644	2303-5645	2303-5646	2303-5647	2303-5648	2303-5649
#5	2303-5651	2303-5652	2303-5653	2303-5654	2303-5655	2303-5656	2303-5657	2303-5658	2303-5659
#6	2303-5661	2303-5662	2303-5663	2303-5664	2303-5665	2303-5666	2303-5667	2303-5668	2303-5669



		E-XPE							
		9 mm	11 mm	13 mm	15 mm	18 mm	21 mm	25 mm	30 mm
#1	2303-5811	2303-5812	2303-5813	2303-5814	2303-5815	2303-5816	2303-5817	2303-5818	2303-5819
#2	2303-5821	2303-5822	2303-5823	2303-5824	2303-5825	2303-5826	2303-5827	2303-5828	2303-5829
#3	2303-5831	2303-5832	2303-5833	2303-5834	2303-5835	2303-5836	2303-5837	2303-5838	2303-5839
#4	2303-5841	2303-5842	2303-5843	2303-5844	2303-5845	2303-5846	2303-5847	2303-5848	2303-5849
#5	2303-5851	2303-5852	2303-5853	2303-5854	2303-5855	2303-5856	2303-5857	2303-5858	2303-5859
#6	2303-5861	2303-5862	2303-5863	2303-5864	2303-5865	2303-5866	2303-5867	2303-5868	2303-5869



Low Constrained Type

		XPE, LC TYPE							
		9 mm	11 mm	13 mm	15 mm	18 mm	21 mm	25 mm	30 mm
#1	2303-5211	2303-5212	2303-5213	2303-5214	2303-5215	2303-5216	2303-5217	2303-5218	2303-5219
#2	2303-5221	2303-5222	2303-5223	2303-5224	2303-5225	2303-5226	2303-5227	2303-5228	2303-5229
#3	2303-5231	2303-5232	2303-5233	2303-5234	2303-5235	2303-5236	2303-5237	2303-5238	2303-5239
#4	2303-5241	2303-5242	2303-5243	2303-5244	2303-5245	2303-5246	2303-5247	2303-5248	2303-5249
#5	2303-5251	2303-5252	2303-5253	2303-5254	2303-5255	2303-5256	2303-5257	2303-5258	2303-5259
#6	2303-5261	2303-5262	2303-5263	2303-5264	2303-5265	2303-5266	2303-5267	2303-5268	2303-5269

# Order Information

 Special Order Items

## Extension Accessories

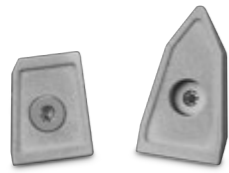

	Distal Femoral Augment					
	4 mm LM / RL	4 mm LL / RM	8 mm LM / RL	8 mm LL / RM	12 mm	16 mm
#1	2603-5111	2603-5211	2603-5112	2603-5212	2603-5313	2603-5314
#2	2603-5121	2603-5221	2603-5122	2603-5222	2603-5323	2603-5324
#3	2603-5131	2603-5231	2603-5132	2603-5232	2603-5333	2603-5334
#4	2603-5141	2603-5241	2603-5142	2603-5242	2603-5343	2603-5344
#5	2603-5151	2603-5251	2603-5152	2603-5252	2603-5353	2603-5354
#6	2603-5161	2603-5261	2603-5162	2603-5262	2603-5363	2603-5364



	Posterior Femoral Augment	
	4 mm	8 mm
#1	2603-5011	2603-5012
#2	2603-5021	2603-5022
#3	2603-5031	2603-5032
#4	2603-5041	2603-5042
#5	2603-5051	2603-5052
#6	2603-5061	2603-5062

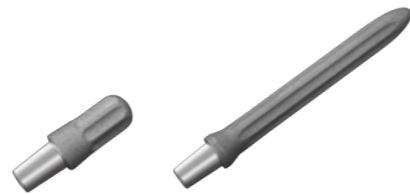

	Straight Stem				
	30 mm	75 mm	100 mm	150 mm	200 mm
Ø10	NA	2703-5011	2703-5021	2703-5051	2703-5061
Ø12	NA	2703-5012	2703-5022	2703-5052	2703-5062
Ø14	2703-5003	2703-5013	2703-5023	2703-5053	2703-5063
Ø16	NA	2703-5014	2703-5024	2703-5054	2703-5064
Ø18	NA	2703-5015	2703-5025	2703-5055	2703-5065
Ø20	NA	2703-5016	2703-5026	2703-5056	2703-5066
Ø22	NA	2703-5017	2703-5027	2703-5057	2703-5067
Ø24	NA	2703-5018	2703-5028	2703-5058	2703-5068



	Curved Stem	
	150 mm	200 mm
Ø10	2703-5031	2703-5041
Ø12	2703-5032	2703-5042
Ø14	2703-5033	2703-5043
Ø16	2703-5034	2703-5044
Ø18	2703-5035	2703-5045
Ø20	2703-5036	2703-5046
Ø22	2703-5037	2703-5047
Ø24	2703-5038	2703-5048

# Order Information

## Extension Accessories



	Tibial Augment			
	5 mm	10 mm	15 mm LM / RL	15 mm LL / RM
#1	2803-5211	2803-5212	2803-5113	2803-5213
#2	2803-5221	2803-5222	2803-5123	2803-5223
#3	2803-5231	2803-5232	2803-5133	2803-5233
#4	2803-5241	2803-5242	2803-5143	2803-5243
#5	2803-5251	2803-5252	2803-5153	2803-5253
#6	2803-5261	2803-5262	2803-5163	2803-5263



Offset Adapter		
2 mm	4 mm	6 mm
2903-1010	2903-1020	2903-1030



Femoral Screw	
M5 x 14 mm	2903-1014



Each Step  
We Care

Each Step  
We Care



Each Step  
We Care

Please note that this Surgical Technique Guide has been authored in the English language. Any translations into other languages have not been reviewed or approved by United Orthopedic Corporation and their accuracy cannot be confirmed. Any translated guide should be reviewed carefully prior to use and questions regarding a Surgical Technique Guide should be directed to United Orthopedic Corporation at [unitedorthopedic.com/contact](http://unitedorthopedic.com/contact)

The CE mark is valid only if it is also printed on the product label.

