

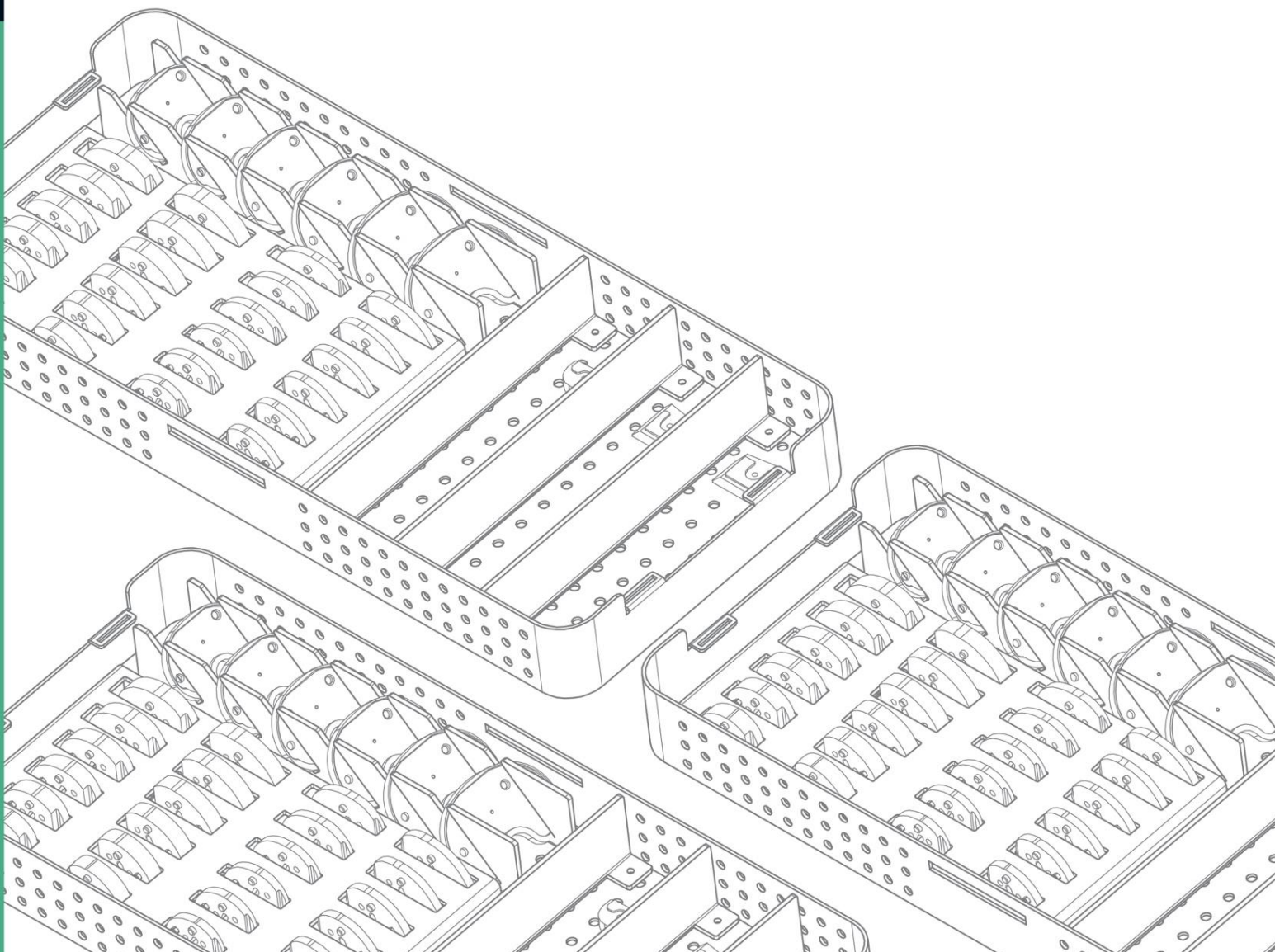











HIP Instrument Disassembly/Assembly and Specific Cleaning Instructions











Content

Clinical Cleaning – Graphical Symbols	1
Cup Impactor, Offset	1
EX. 9206-1105	1
Cup Locator Block	2
EX. 9203-2101	2
Cup Reamer Handle	3
EX. 9203-1201	3
EX. 9203-1201-RA	3
EX. 9203-1201-RB	3
Cup Reamer Handle, Straight, EZ Clean	4
EX. 9206-1101	4
Cup Reamer Handle, Offset	5
EX. 9206-1102	5
Cup Reamer Handle, Offset (Carbon)	7
EX. 9206-1102-RA	7
EX. 9206-1102-RB	7

Clinical Cleaning – Graphical Symbols

Pictogram	Title Description	Standard/Ref. No.
	Direction in general Direction of the motion or force (push, pull and bend)	ISO 14617-2 / 241
	Alternative directions in general Two-way direction of the motion or force.	ISO 14617-2 / 245
	Limited rectilinear motion To indicate limited rectilinear motion.	ISO 7000 / IEC 60417 / 0001
	Direction of continuous rotation To indicate that a control, or an object by means of a control, can be moved in a clockwise rotary motion.	ISO 7000 / IEC 60417 / 0004
	Limited rotation To indicate limited rotary motion in a clockwise direction.	ISO 7000 / IEC 60417 / 0006
	Rotation in two directions To indicate that a control, or an object by means of a control, can be moved in a clockwise and anticlockwise rotation.	ISO 7000 / IEC 60417 / 0005
	Rotational movement clockwise To indicate clockwise rotational movement with the axis of rotation parallel to the direction of production.	ISO 7000 / IEC 60417 / 0978
	Rotational movement anticlockwise To indicate anticlockwise rotational movement with the axis of rotation parallel to the direction of production.	ISO 7000 / IEC 60417 / 0976
	Lock; tighten To indicate the function of locking or clamping two machine parts together, or location of a machine element in a fixed position.	ISO 7000 / IEC 60417 / 0018
	Unlock; unclamp To indicate the function of releasing two machine elements locked or clamped together, or the releasing of a machine element from a fixed position.	ISO 7000 / IEC 60417 / 0019
	Caution Caution or Instructions for Use.	ISO 15223-1 / 5.4.4 EN 980 / 5.11
	Tap water flush To identify an open water tap or connection or the control to open up the water supply.	ISO 7000 / IEC 60417 / 5574

	Spraying To indicate a reference to the spraying of liquid.	ISO 7000 / IEC 60417 / 0073
	Rotary brush To identify a rotary brush (for example, on a control which operates the rotary brush).	ISO 7000 / IEC 60417 / 0307
	Locking To identify on a control that a function is locked or to show the locked status.	ISO 7000 / IEC 60417 / 5569
	Unlocking To identify on a control that a function is not locked or to show the unlocked status.	ISO 7000 / IEC 60417 / 5570
	Manufacturer Indicate the medical device manufacturer, as defined in EU Directives 90/385/EEC, 93/42/EEC and 98/79/EC.	ISO 15223-1 / 5.1.1 EN 980 / 5.12
	Authorized representative in the European Community Indicate the authorized representative in the European Community.	ISO 15223-1 / 5.1.2 EN 980 / 5.13
	Success To identify the control to acknowledge affirmatively and to indicate the status of acknowledgement, or to indicate the successful status.	ISO 7000 / IEC 60417 / 6334A
	Failure To indicate the status of negative acknowledgement, or to indicate the failed status.	ISO 7000 / IEC 60417 / 6335B



FOR MORE DETAILED CLEANING PROCEDURES PLEASE REFER TO UOC-UM-UN-00029 (MT50867), REPROCESSING INSTRUCTIONS FOR REUSABLE SURGICAL INSTRUMENTS.



United Orthopedic Corporation
No. 57, Park Ave 2, Science Park,
Hsinchu, 300, Taiwan.
TEL: +886-3-5773351
FAX: +886-3-5777156
E-MAIL: service@unitedorthopedic.com



mdi Europa GmbH
Langenhagener Straße 71
30855 Langenhagen, Germany
TEL: +49-511-3908 9530
FAX: +49-511-3908 9539

Cup Impactor, Offset

EX. 9206-1105

Disassembly & Assembly

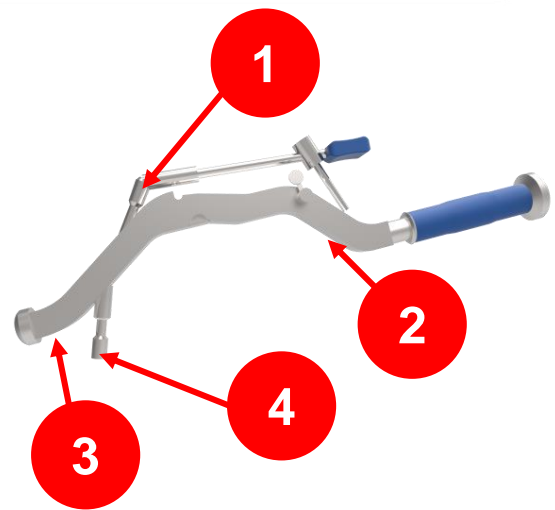
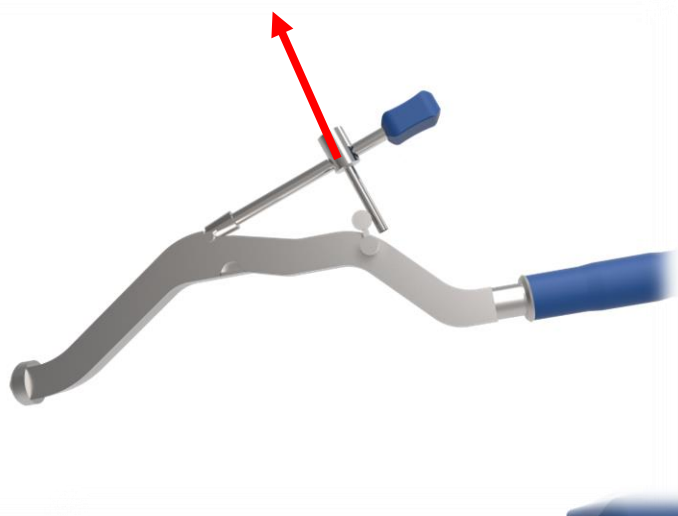
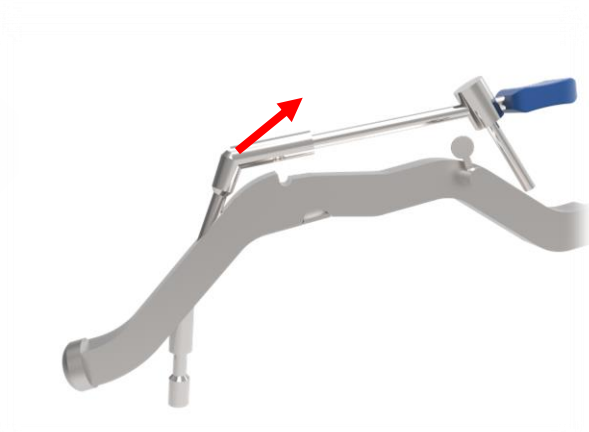
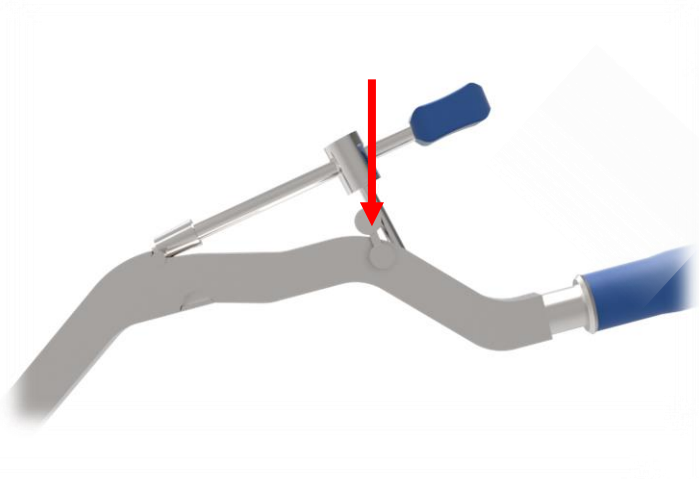
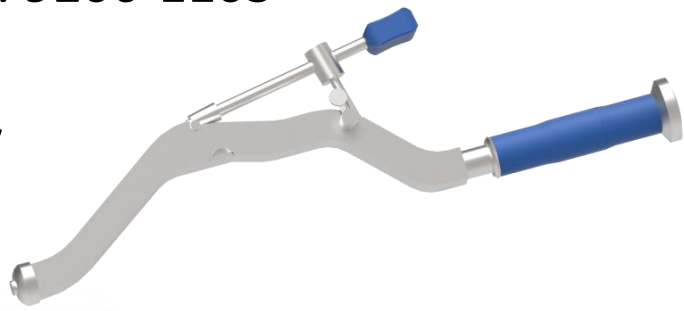

Cleaning



Cup Locator Block

EX. 9203-2101

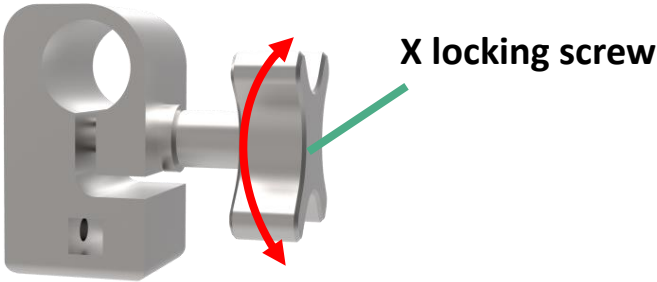

Disassembly

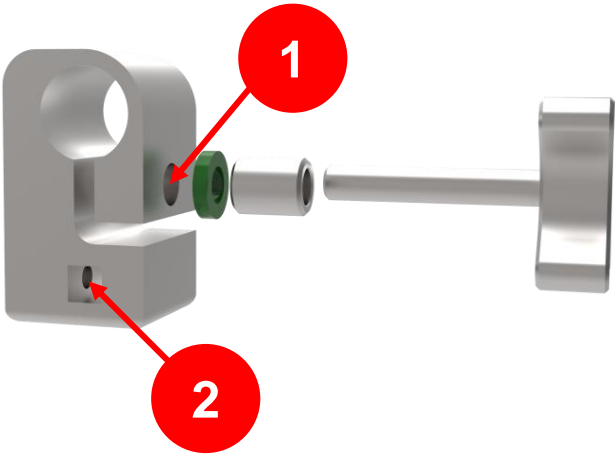
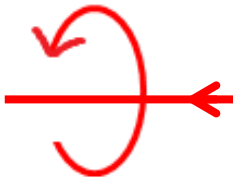

Assembly

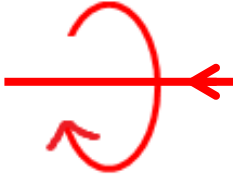

Cleaning

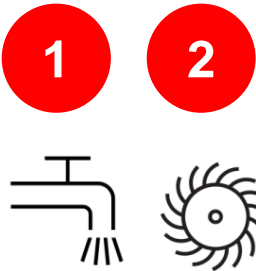

Cup Reamer Handle

EX. 9203-1201

EX. 9203-1201-RA

EX. 9203-1201-RB

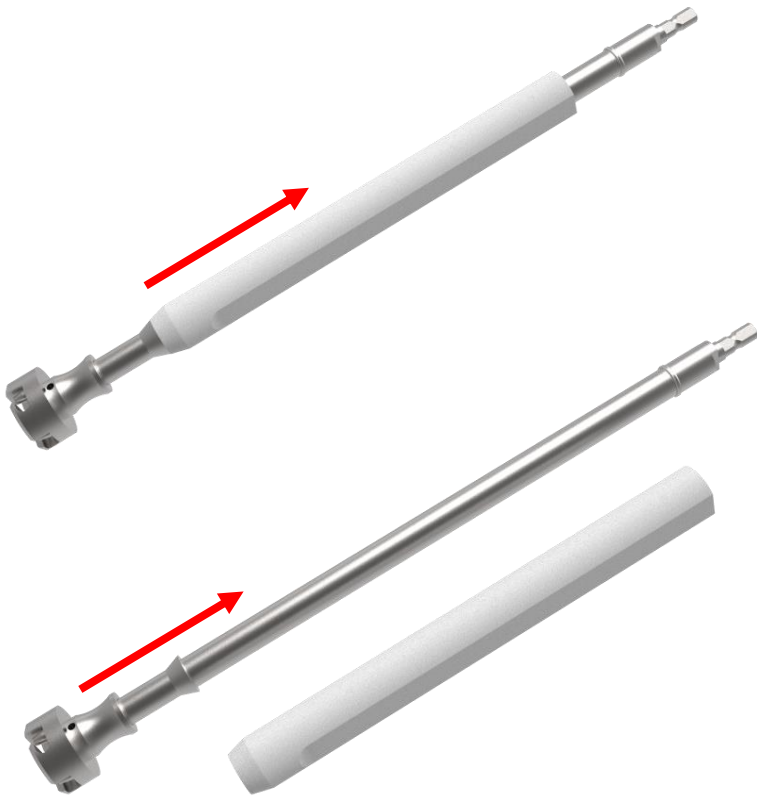

Cleaning

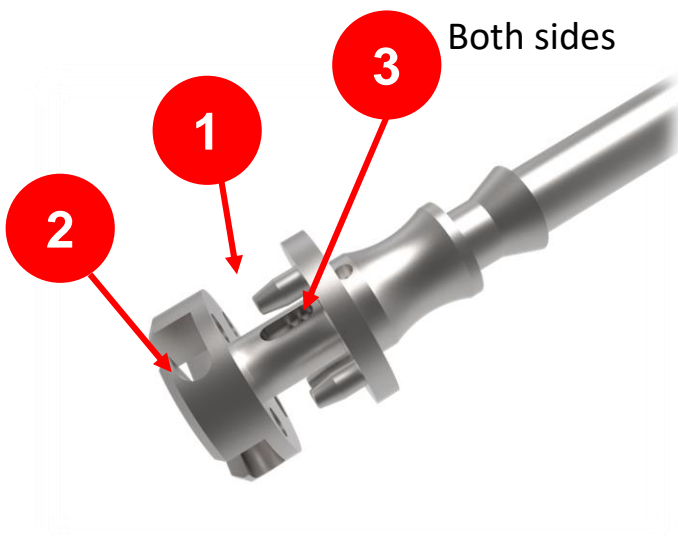
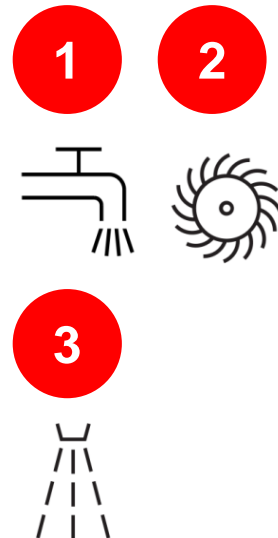

Cup Reamer Handle, Straight, EZ Clean

EX. 9206-1101



Disassembly

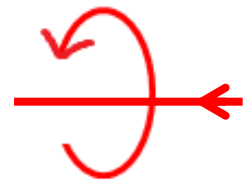
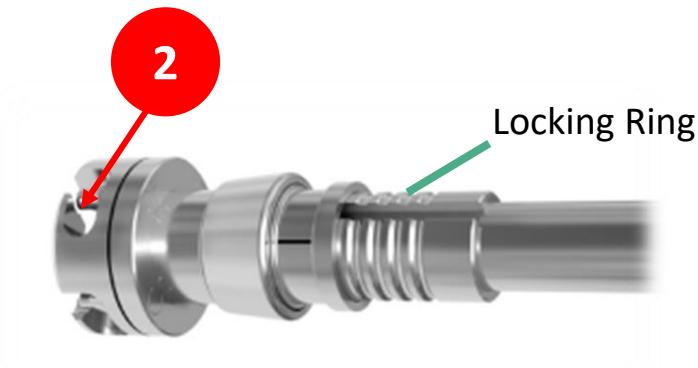

Assembly

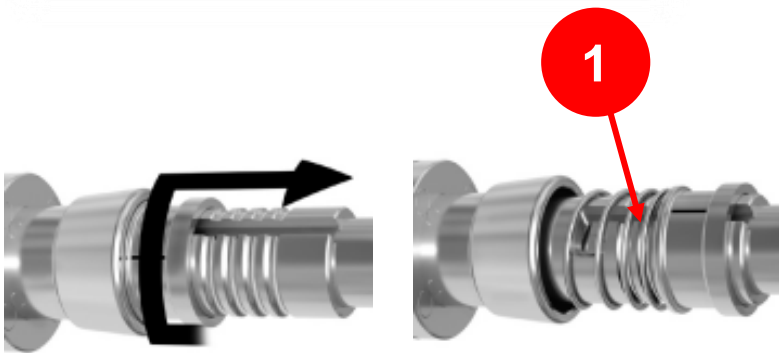

Cleaning

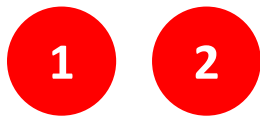

Cup Reamer Handle, Offset

EX. 9206-1102

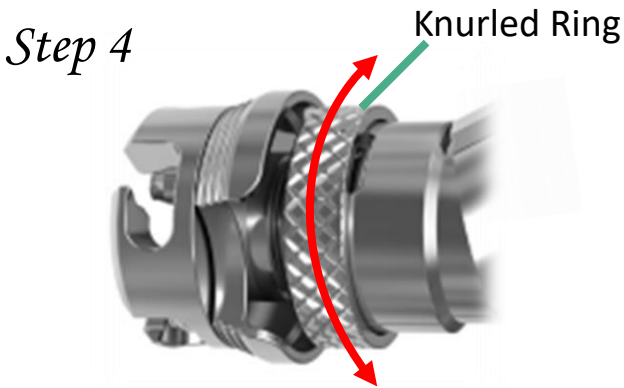
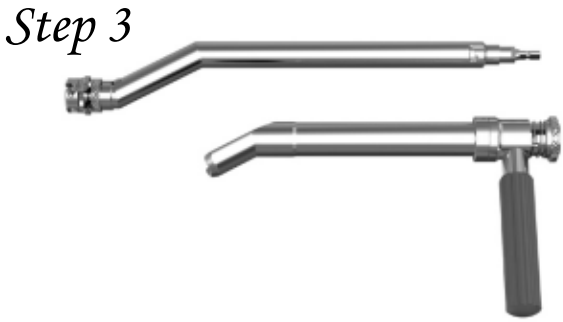
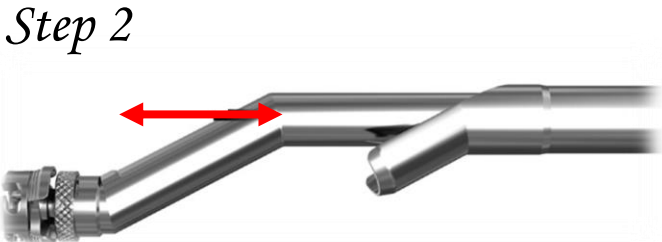
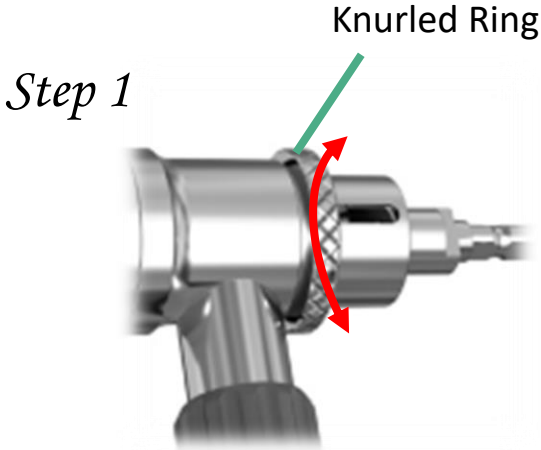

Disassembly

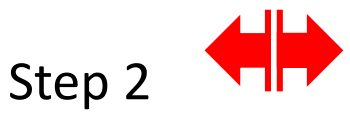
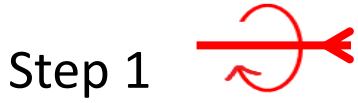

Step 6

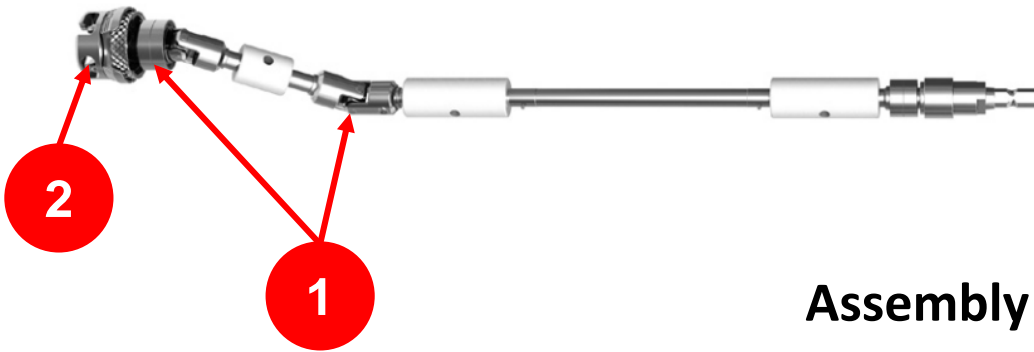

Assembly

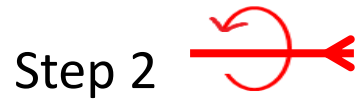

Cleaning

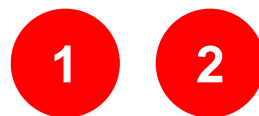

Retain the disassembly before sterilization.

Cup Reamer Handle, Offset (Carbon)

EX. 9206-1102-RA

EX. 9206-1102-RB

Disassembly

Step 1

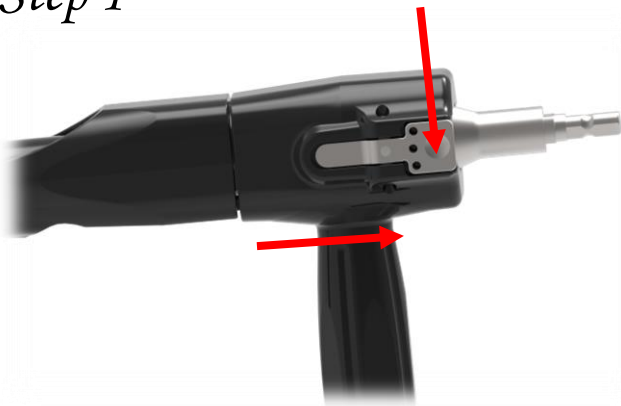

Step 2

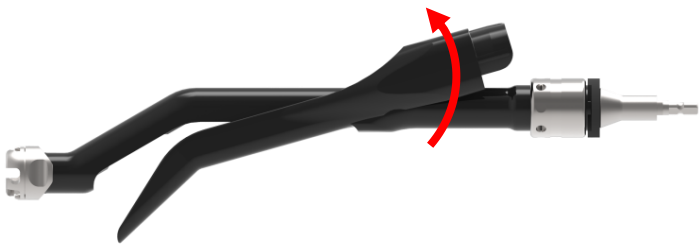

Step 4



Step 3

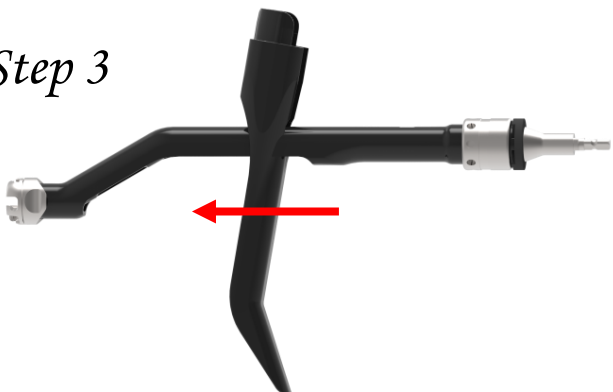

Step 5

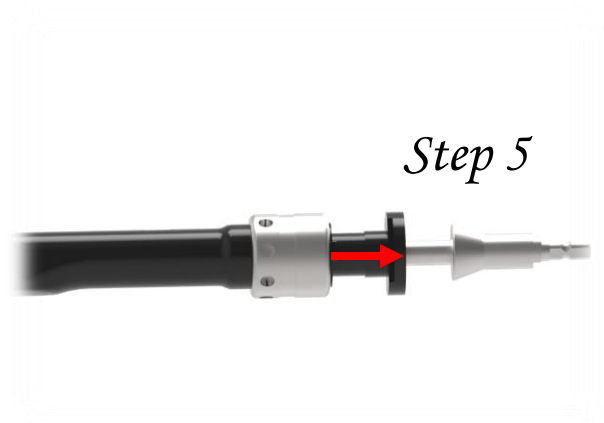

Step 6

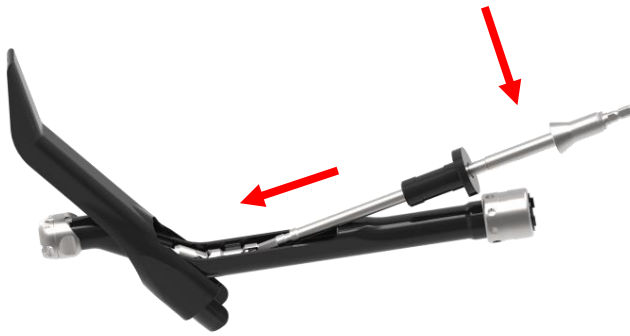

Step 8

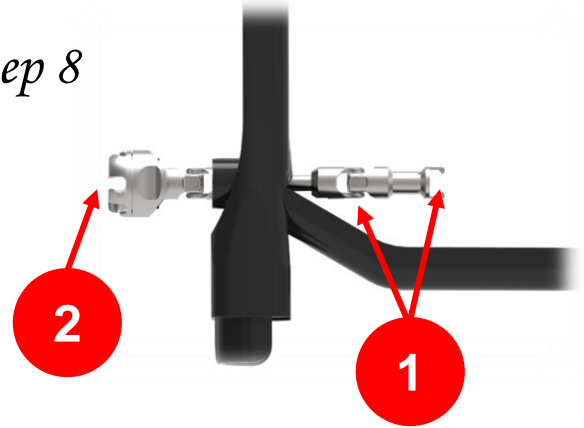

Step 9

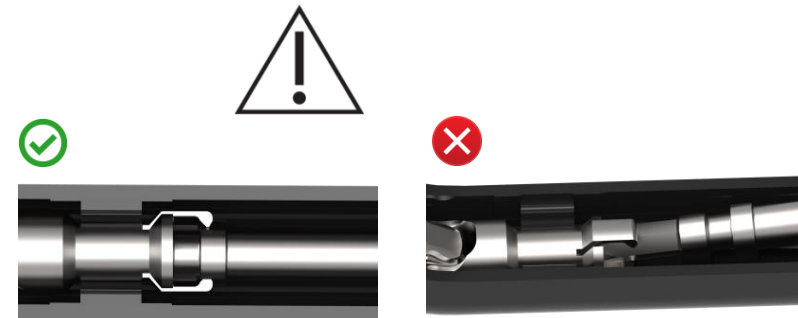
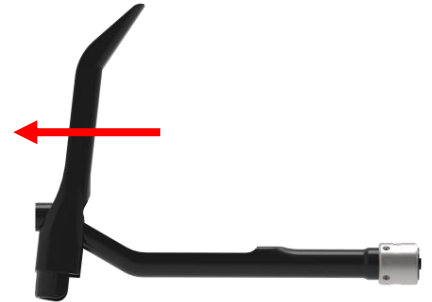

Step 7

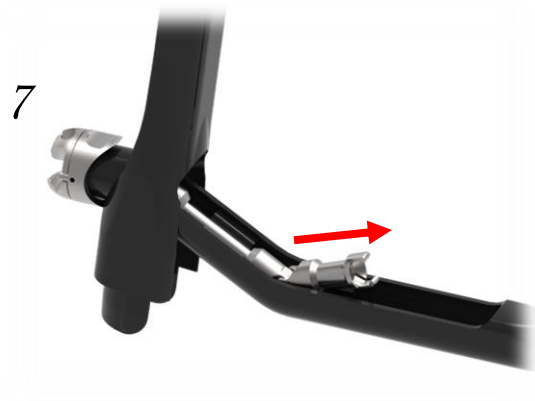

Cleaning

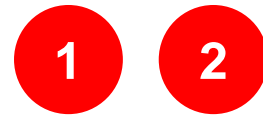

 Retain the disassembly before sterilization.

Assembly

Step 1

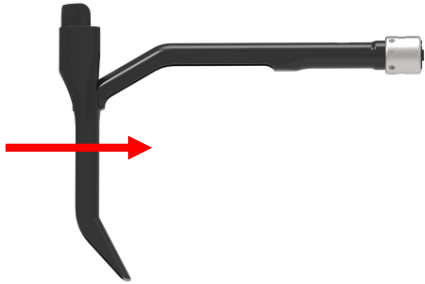

Step 2

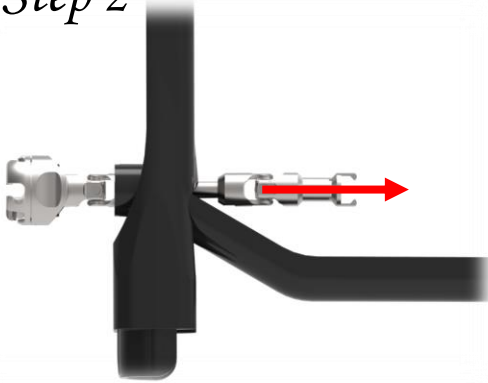

Step 3

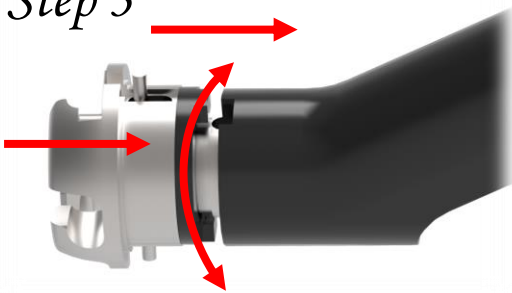

Step 4



Step 5

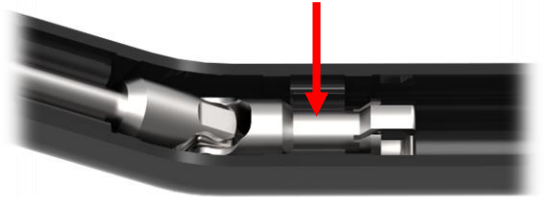

Step 6

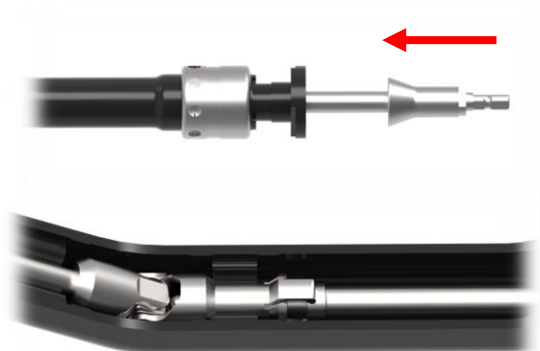

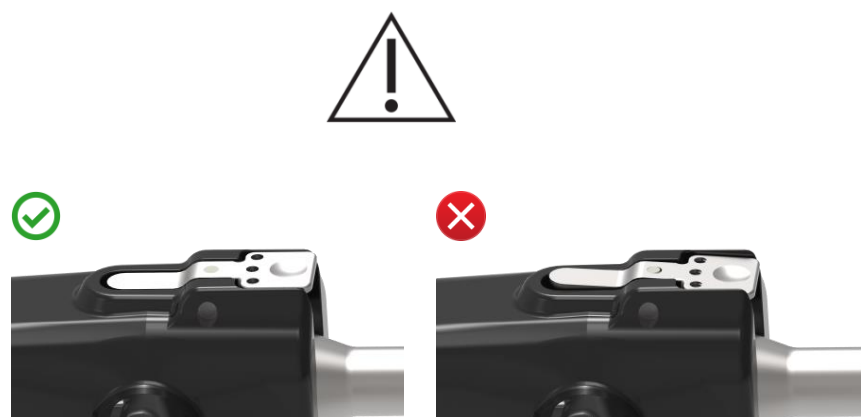
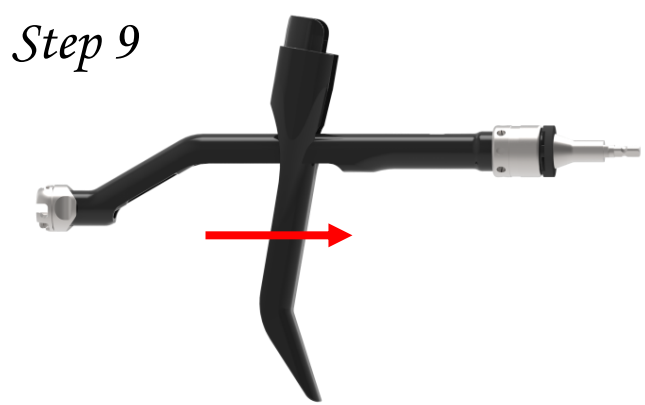
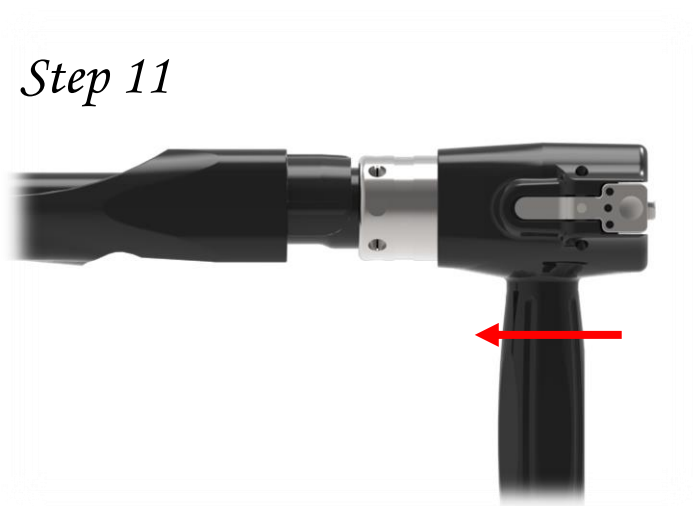
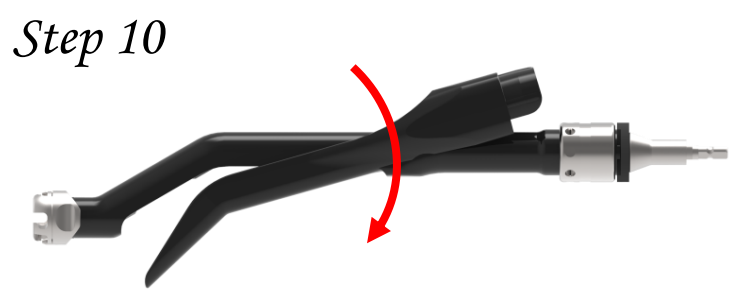
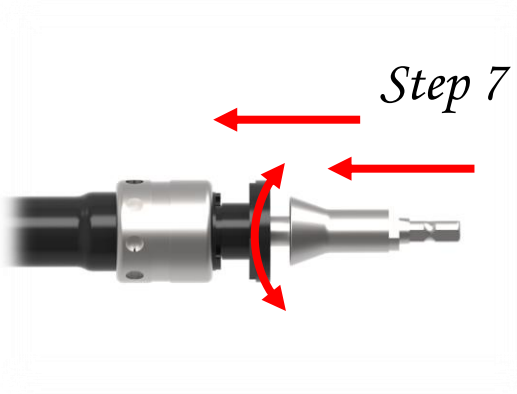

Please note that this Surgical Technique Guide has been authored in the English language. Any translations into other languages have not been reviewed or approved by United Orthopedic Corporation and their accuracy cannot be confirmed. Any translated guide should be reviewed carefully prior to use and questions regarding a Surgical Technique Guide should be directed to United Orthopedic Corporation at unitedorthopedic.com/contact

The CE mark is valid only if it is also printed on the product label.

